

ACMS 1st Floor

RN.104 (1131)
172.26.75.221

108 (1131)
172.26.75.222



RN.106 (1131)
172.26.75.223

RN.105 (1131)
172.26.75.224



LNF (1131)
172.26.75.226

172.26.75.231
Conference
Room(5602)

ACMS 2nd Floor

RN-208-B (1131)
172.26.75.227

RN-201-B (1131)
172.26.75.227

RN-203-B (1131)
172.26.75.225

RN-210 (1131)
172.26.75.229



2nd Floor

RN-203-A (1131)
172.26.75.230

ACES-1st Floor

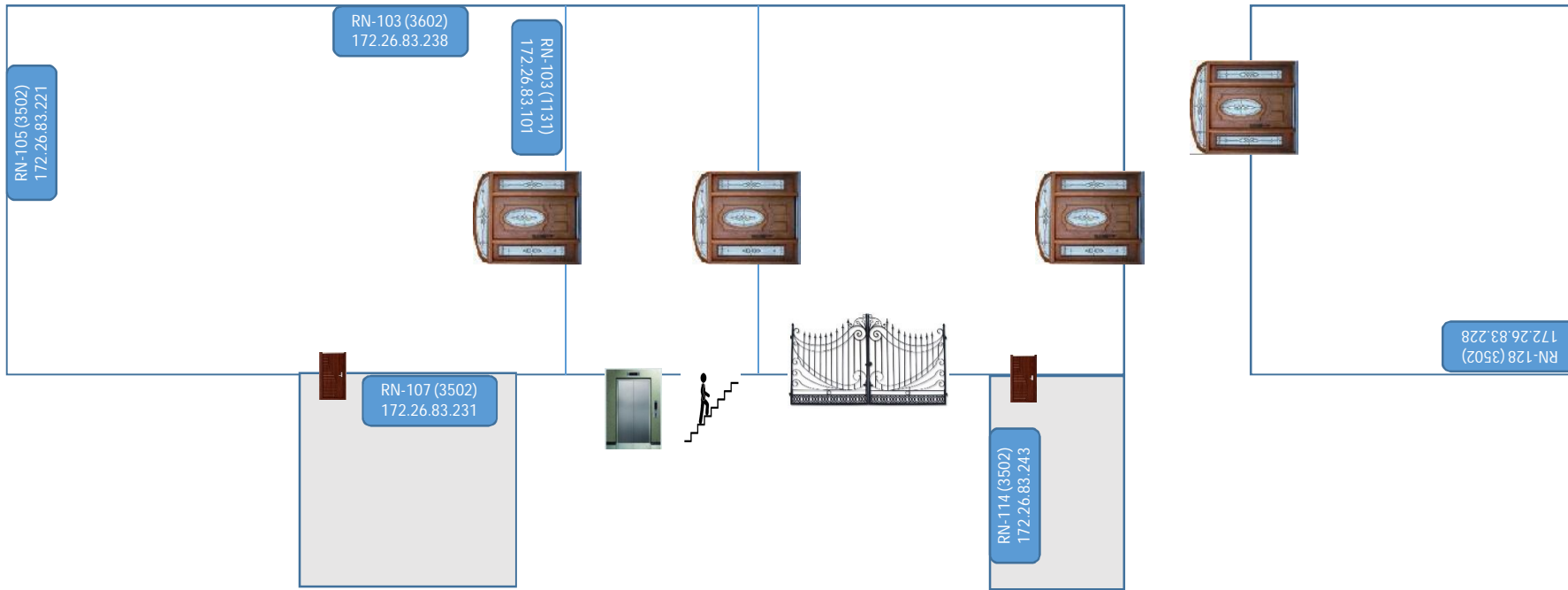

ACES-2nd Floor

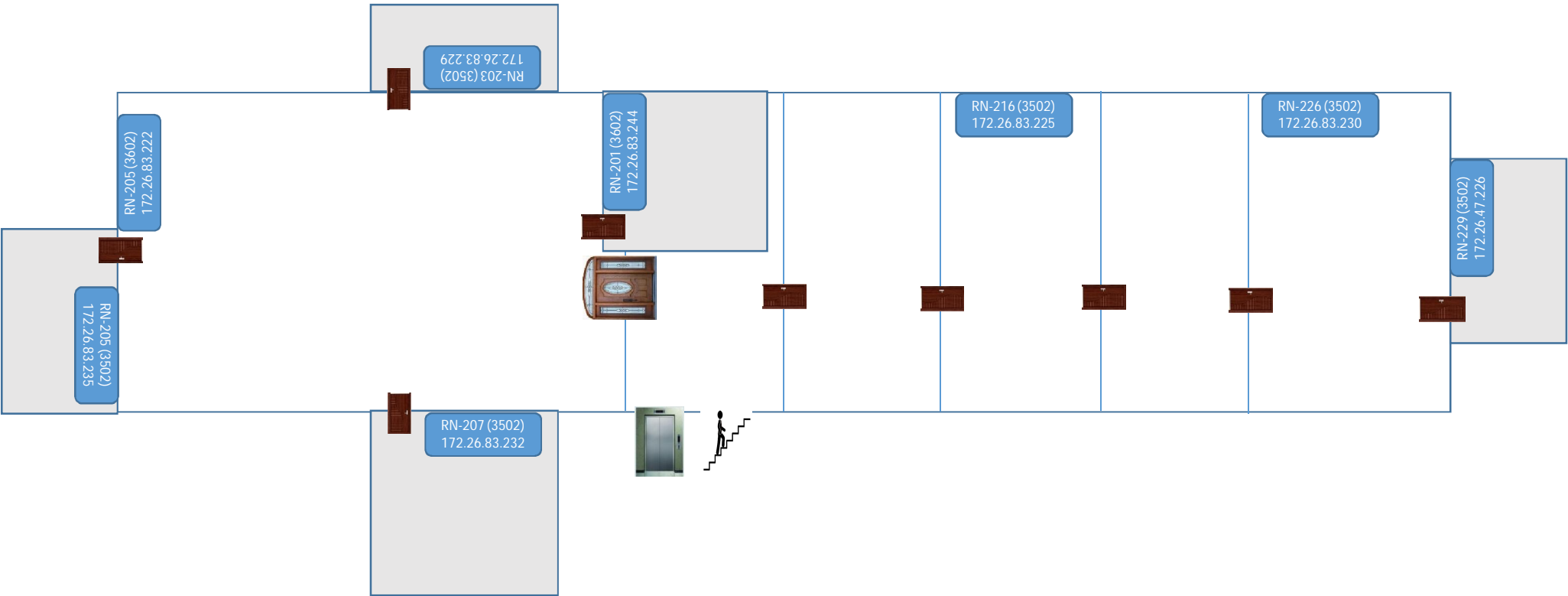

ACES-3rd Floor

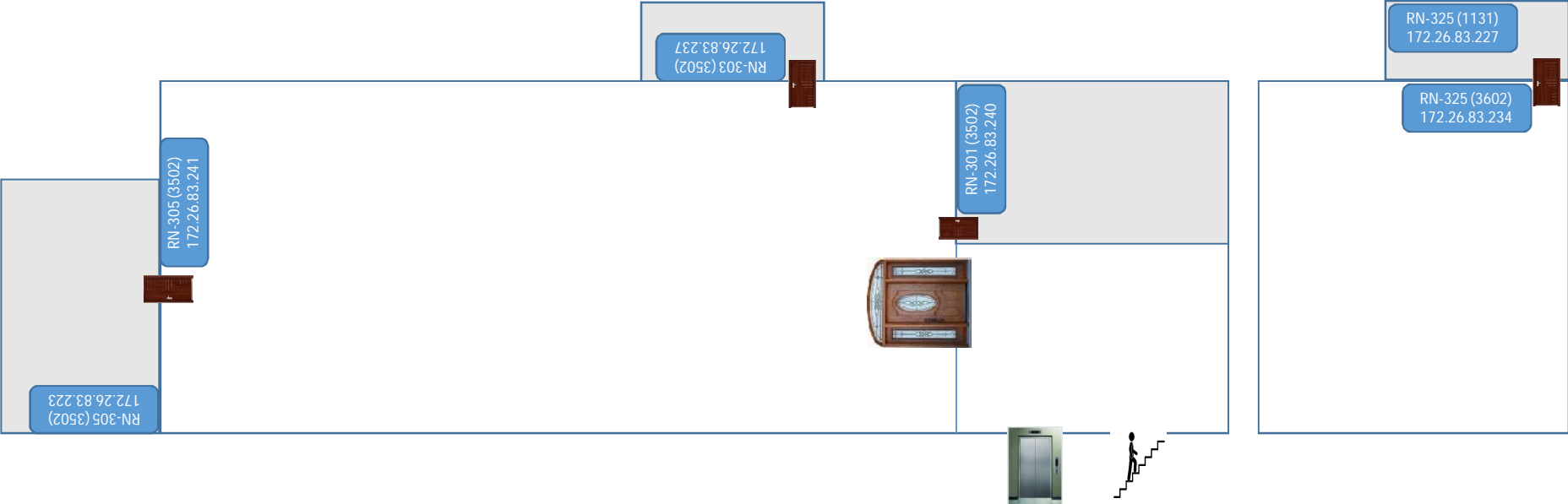

ACES-4th Floor

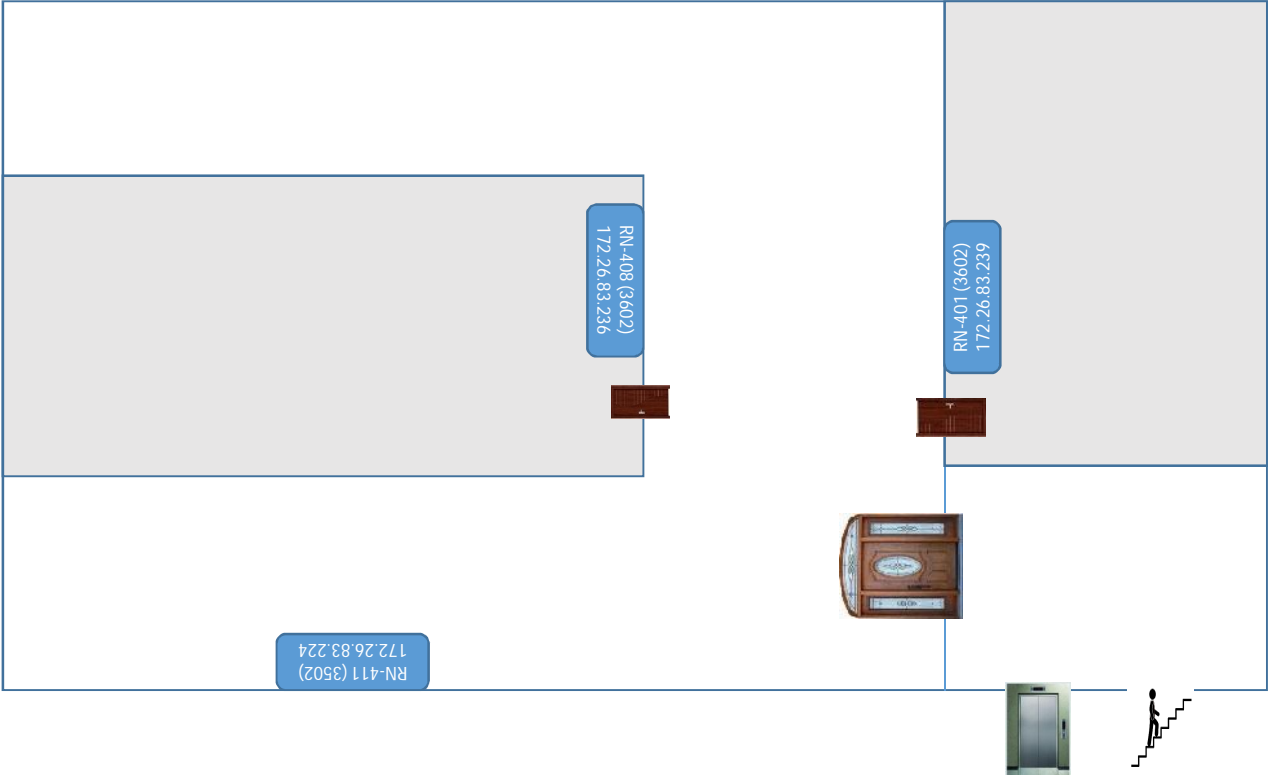

ALUMNI Ground Floor

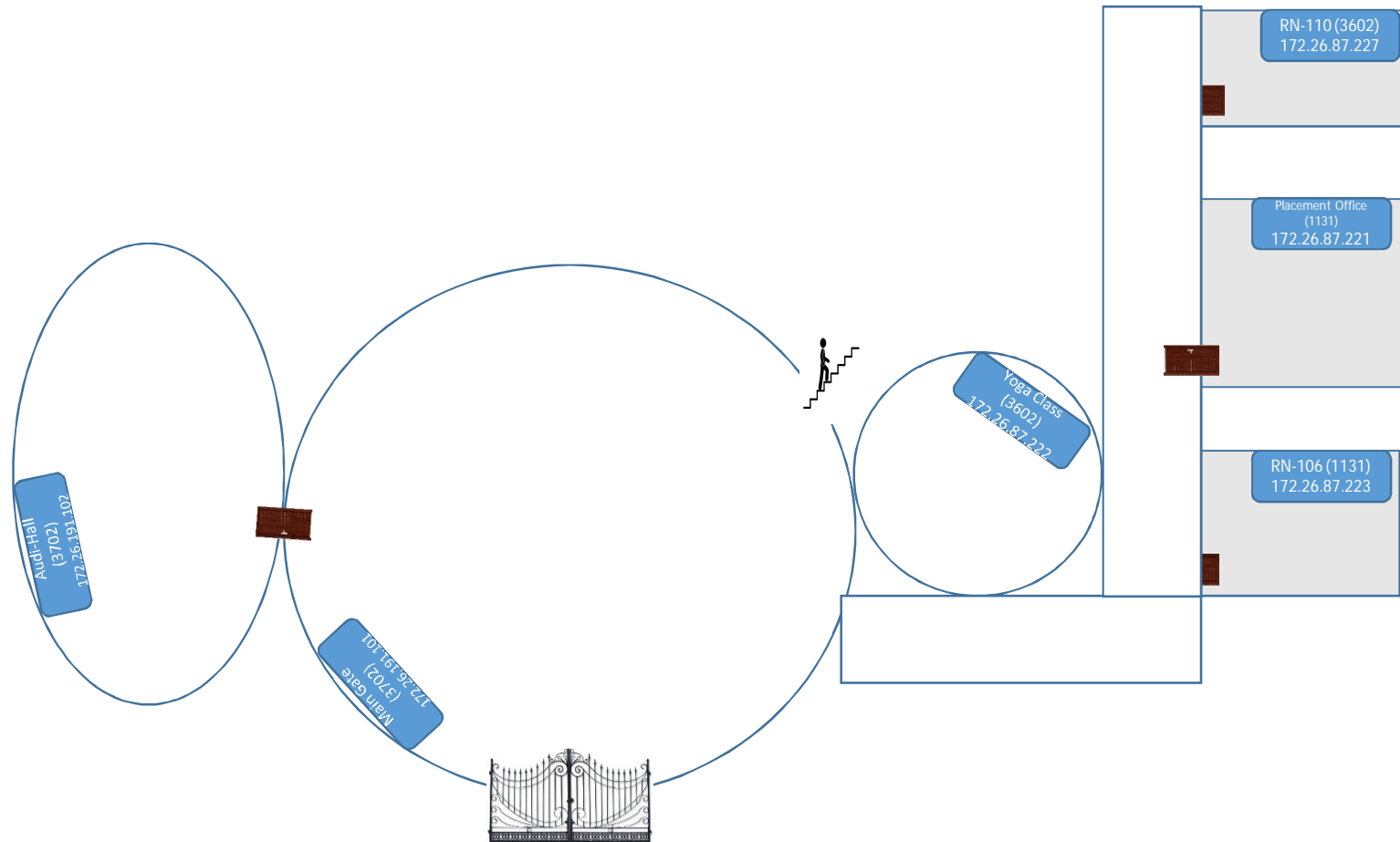

ALUMNI 1st Floor

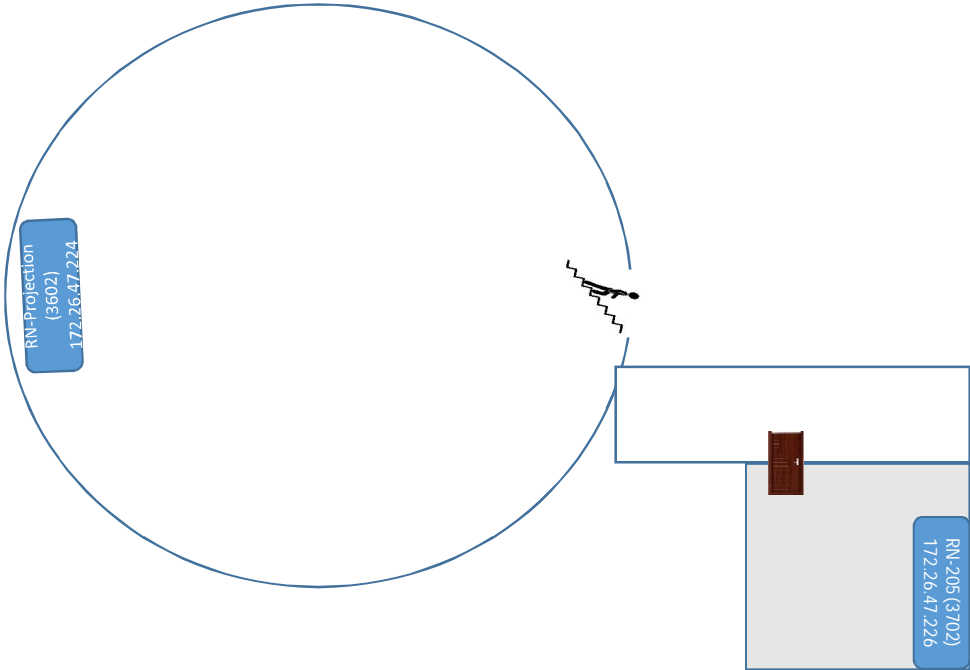

Auditorium



Aerospace

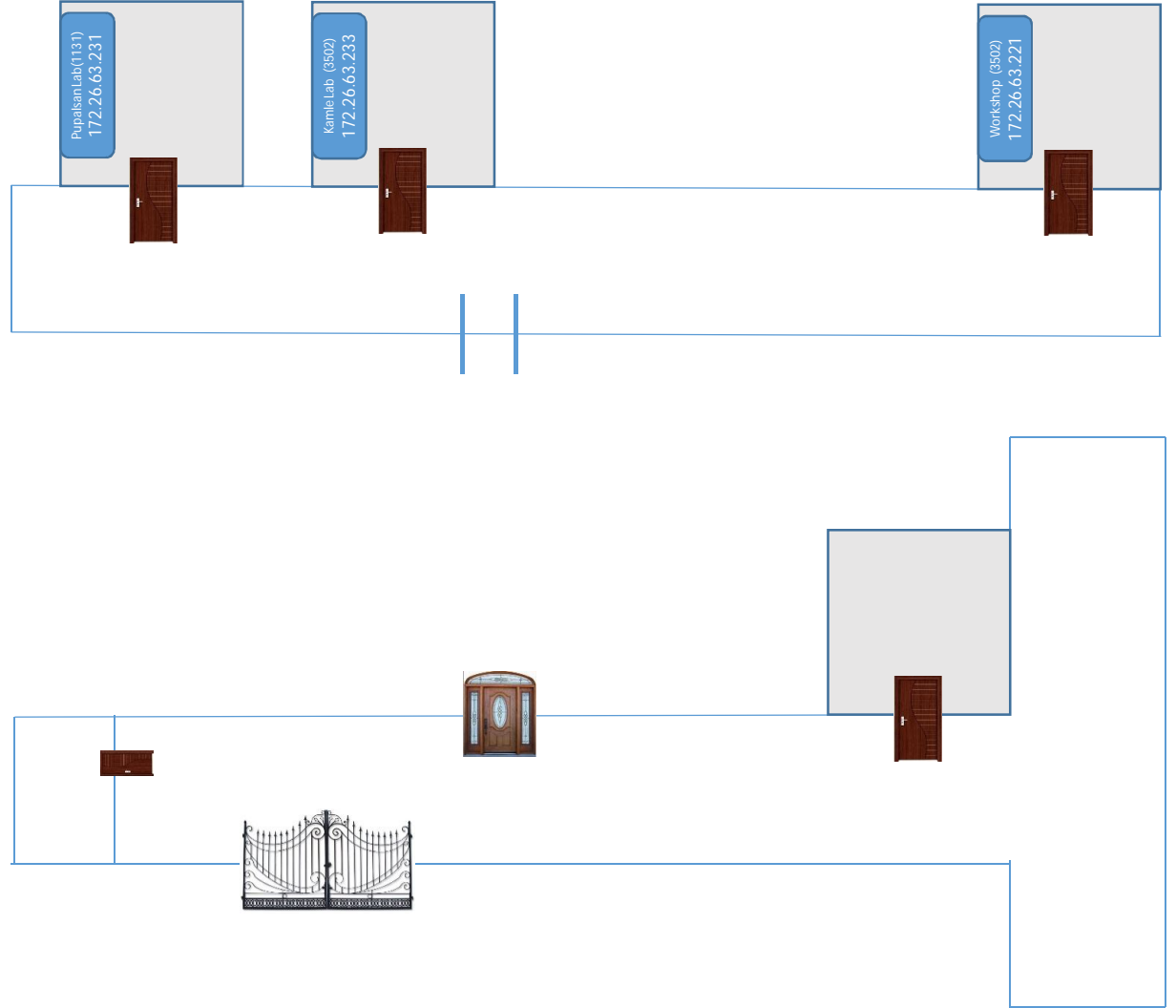
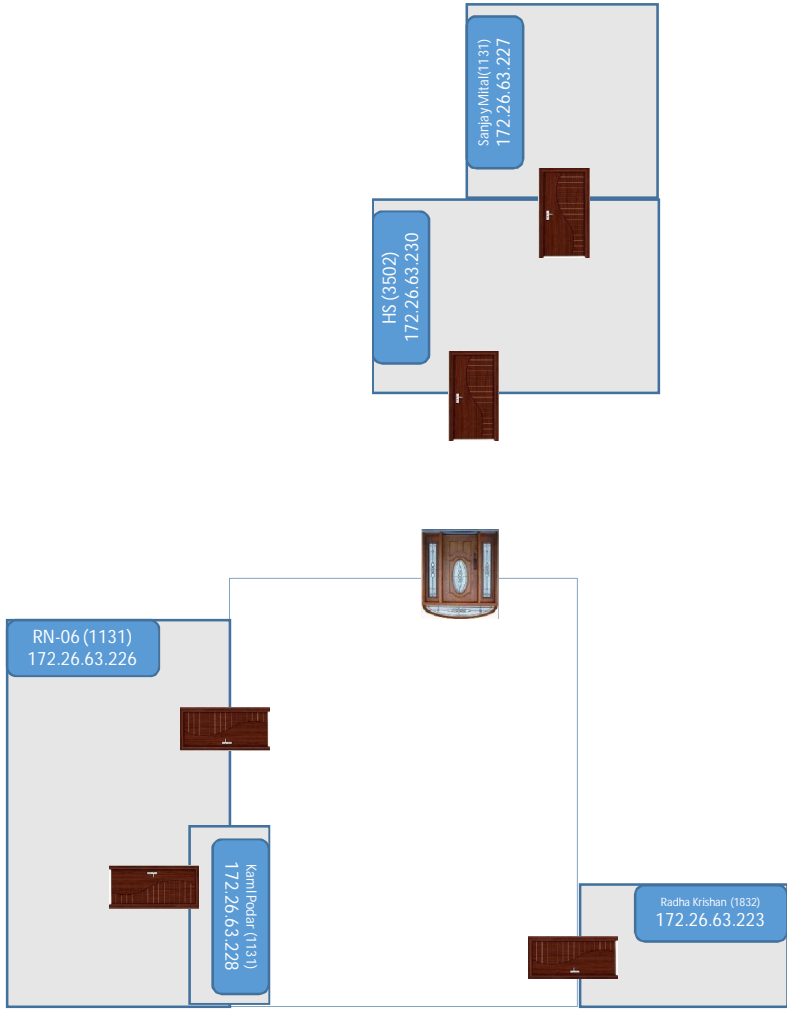

BSBE GF

Block C (3602)
172.26.91.246

Lab-1 (3502)
172.26.91.221

Lab-2 (1131)
172.26.91.226

Lab-3 (1131)
172.26.91.227



CF Lab (1131)
172.26.91.236

CF Lab (1131)
172.26.91.232

CF (1131)
172.26.91.229



Lab-4 (3602)
172.26.91.248

Lab-5 (3502)
172.26.91.233

Lab-6 (1131)
172.26.91.231

BSBE 1st Floor

Lab-7 (1131)
172.26.91.237

Lab-8 (1131)
172.26.91.239

Lab-9 (1131)
172.26.91.240

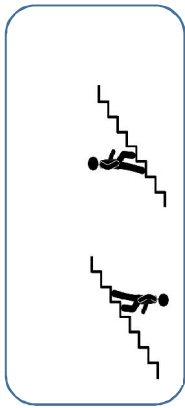

CF (1131)
172.26.91.238

BSBE Head (3502)
172.26.91.249

Lab-10 (3502)
172.26.91.228

Lab-11 (1131)
172.26.91.235

Lab-12 (1131)
172.26.91.225

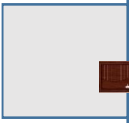

BSBE 2nd Floor

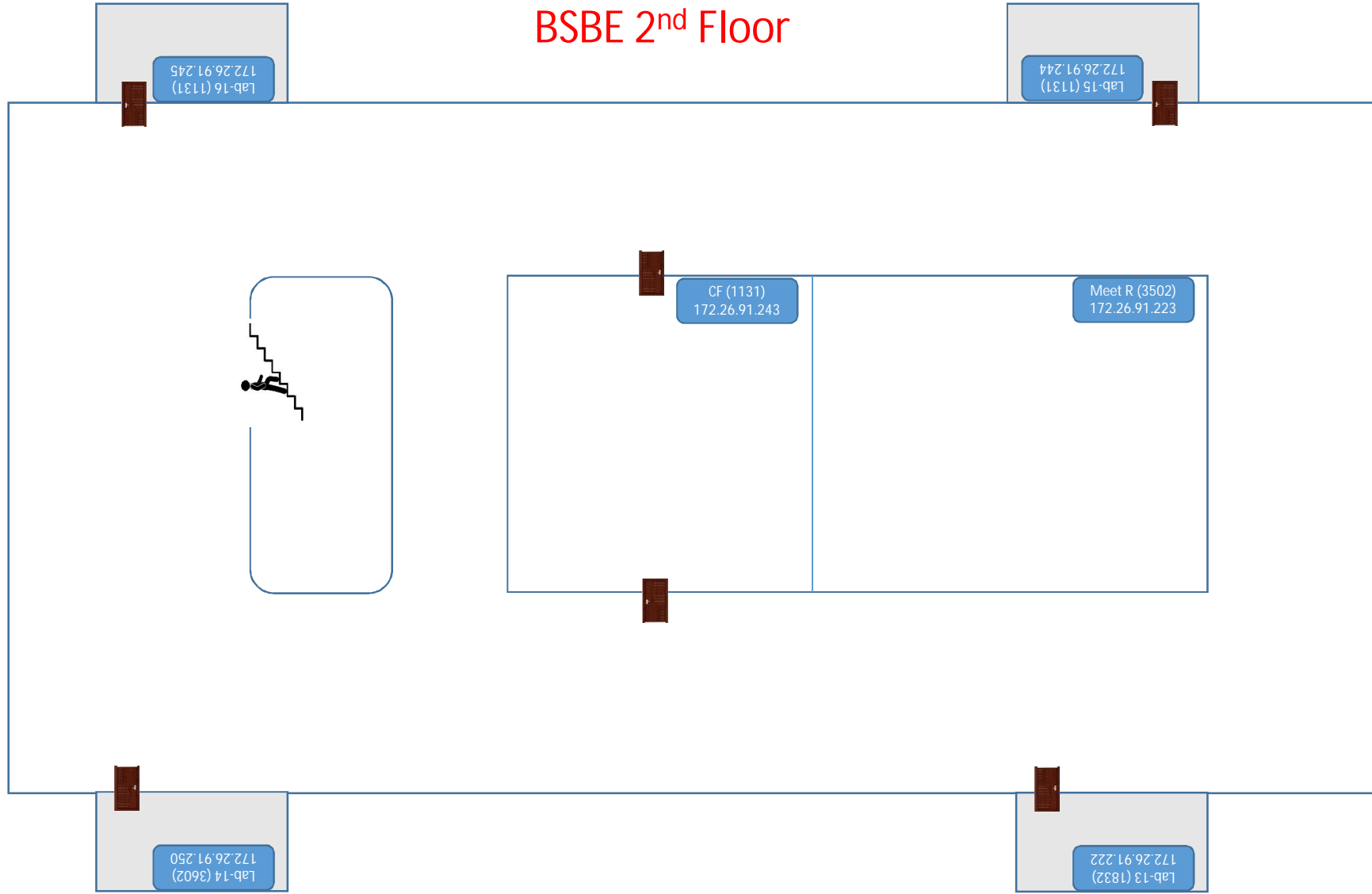

Campus School

Office (3502)
172.26.103.225



DOAA JEE G F

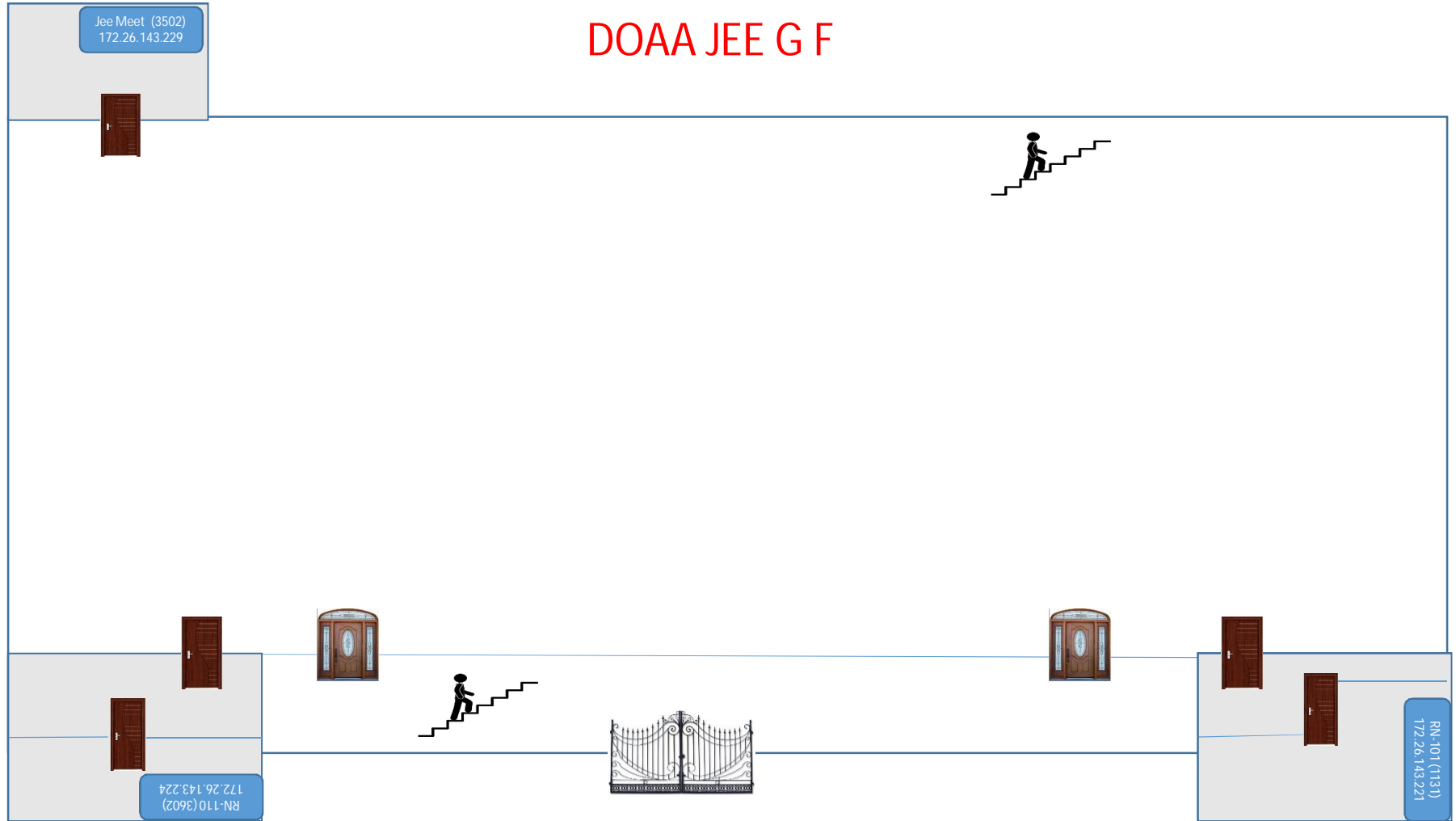

DOAA JEE 1st Floor

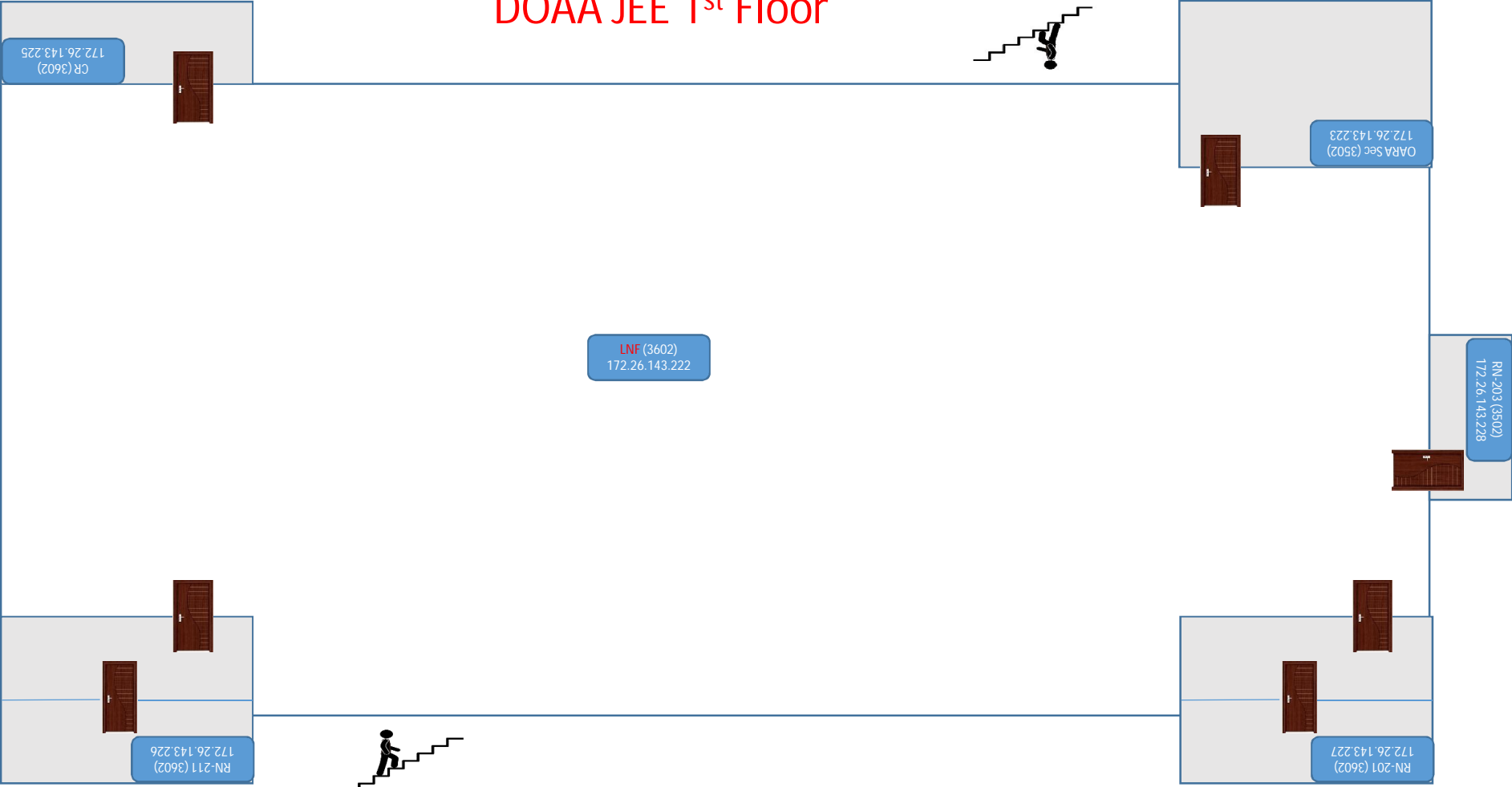

Environmental GF

RN-102 (1131)
172.26.3.231

RN-107 (3502)
172.26.3.224



RN-132 (3502)
172.26.3.225



RN-127 (3502)
172.26.3.223



RN-126 (3602)
172.26.3.233



Environmental 1st Floor

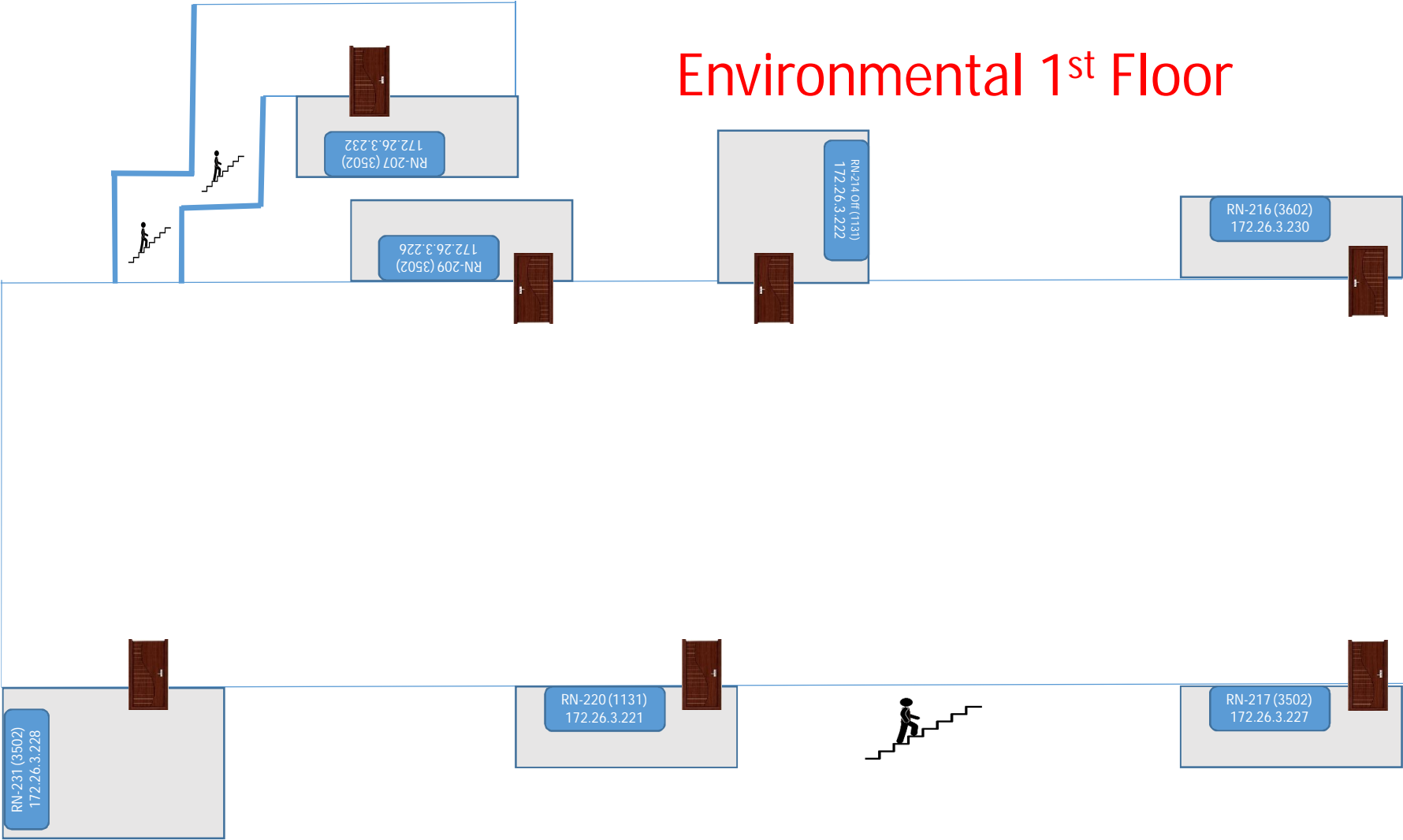

FB 1st Floor

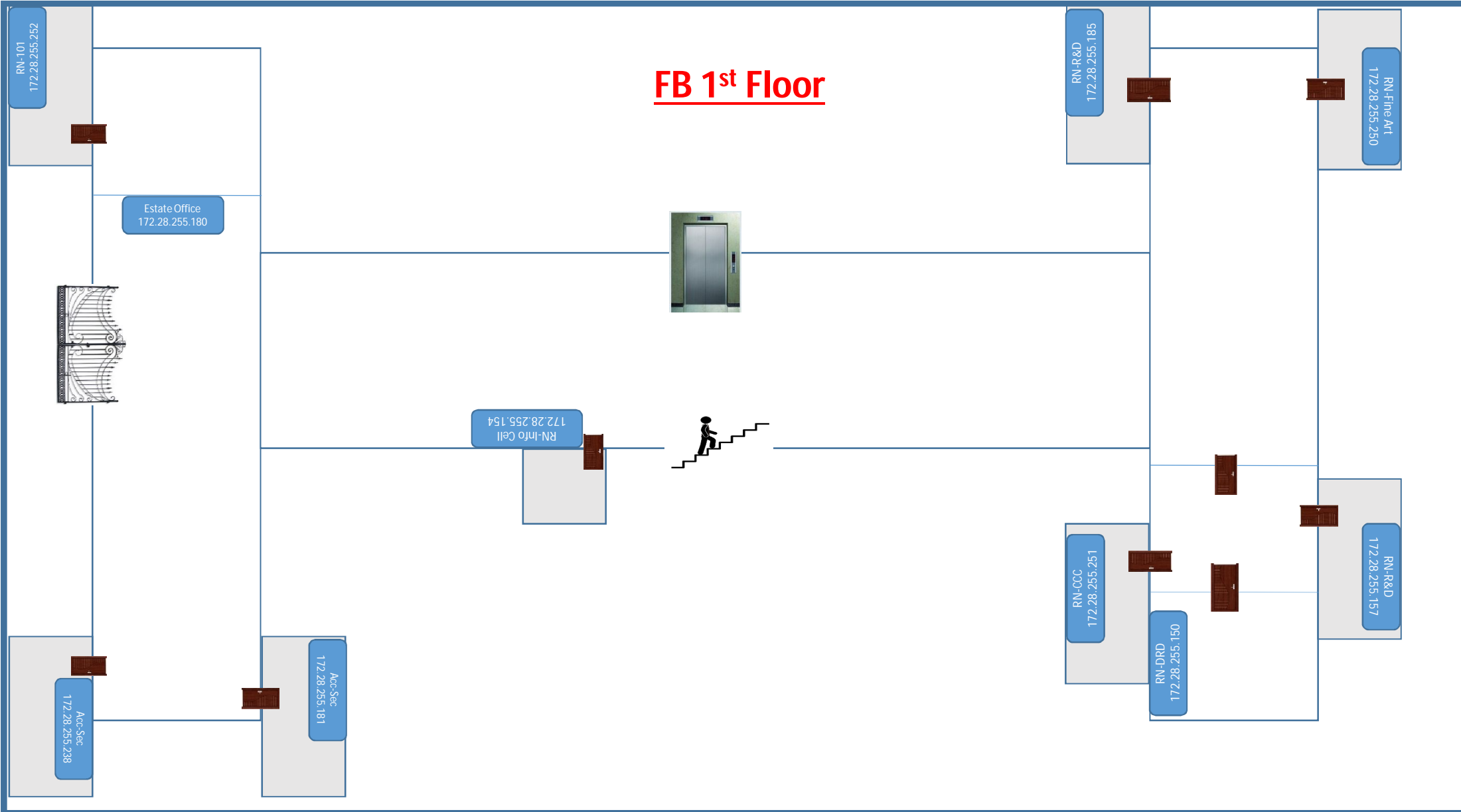

FB 2nd Floor



FB 3rd Floor

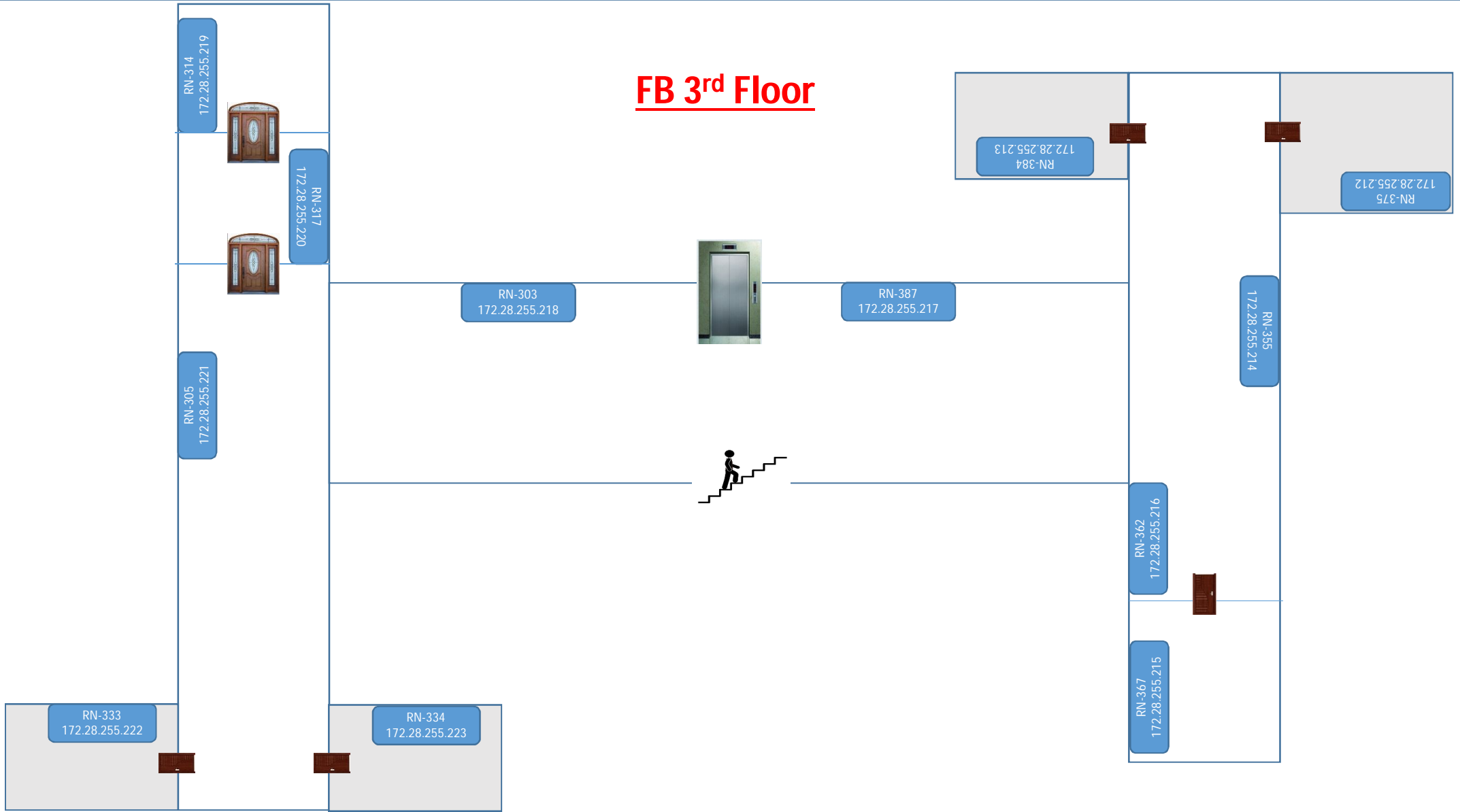

FB 4th Floor

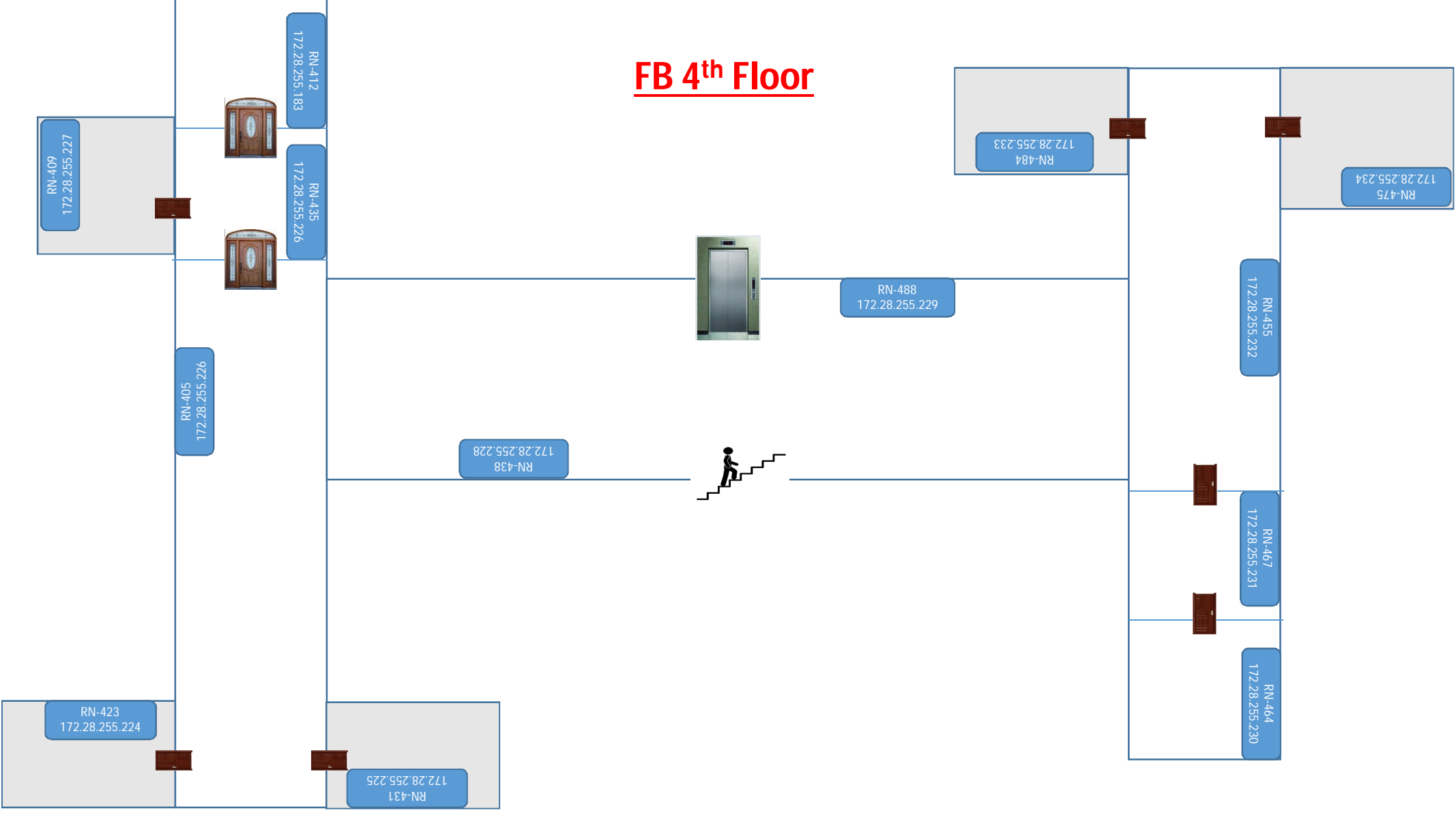

FB 5th Floor

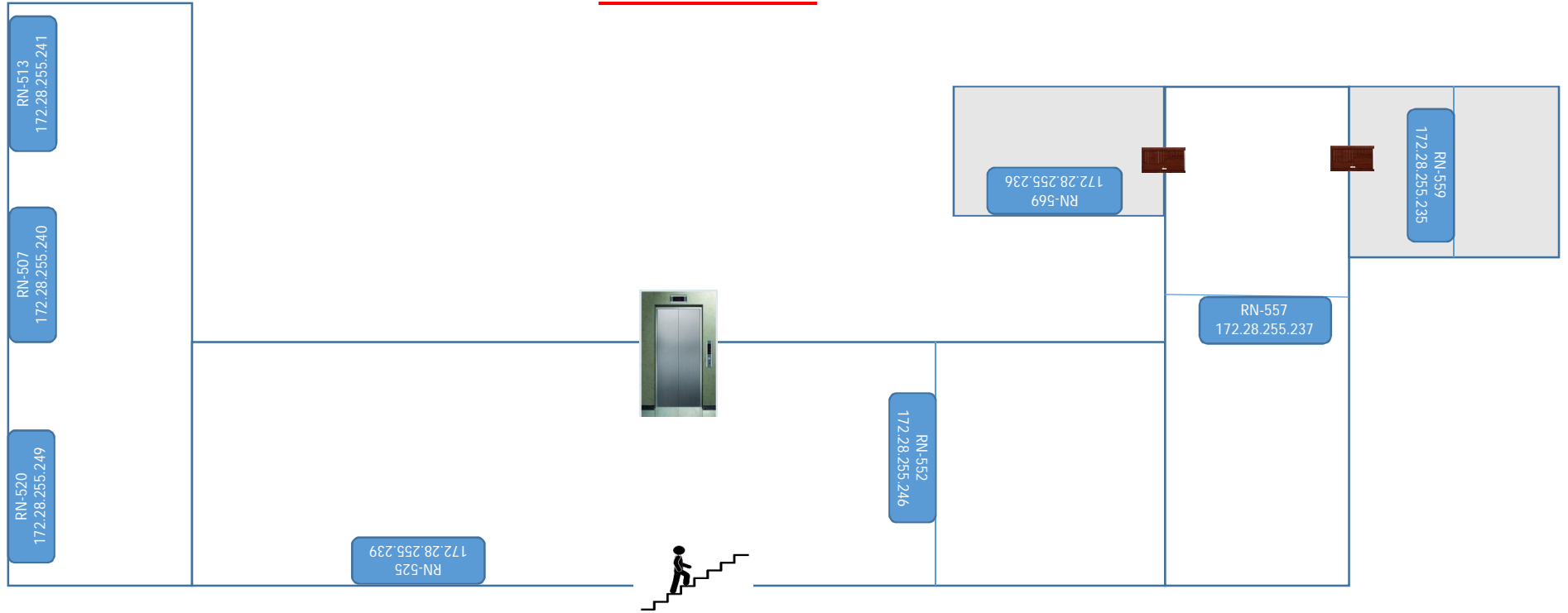

FB 6th Floor

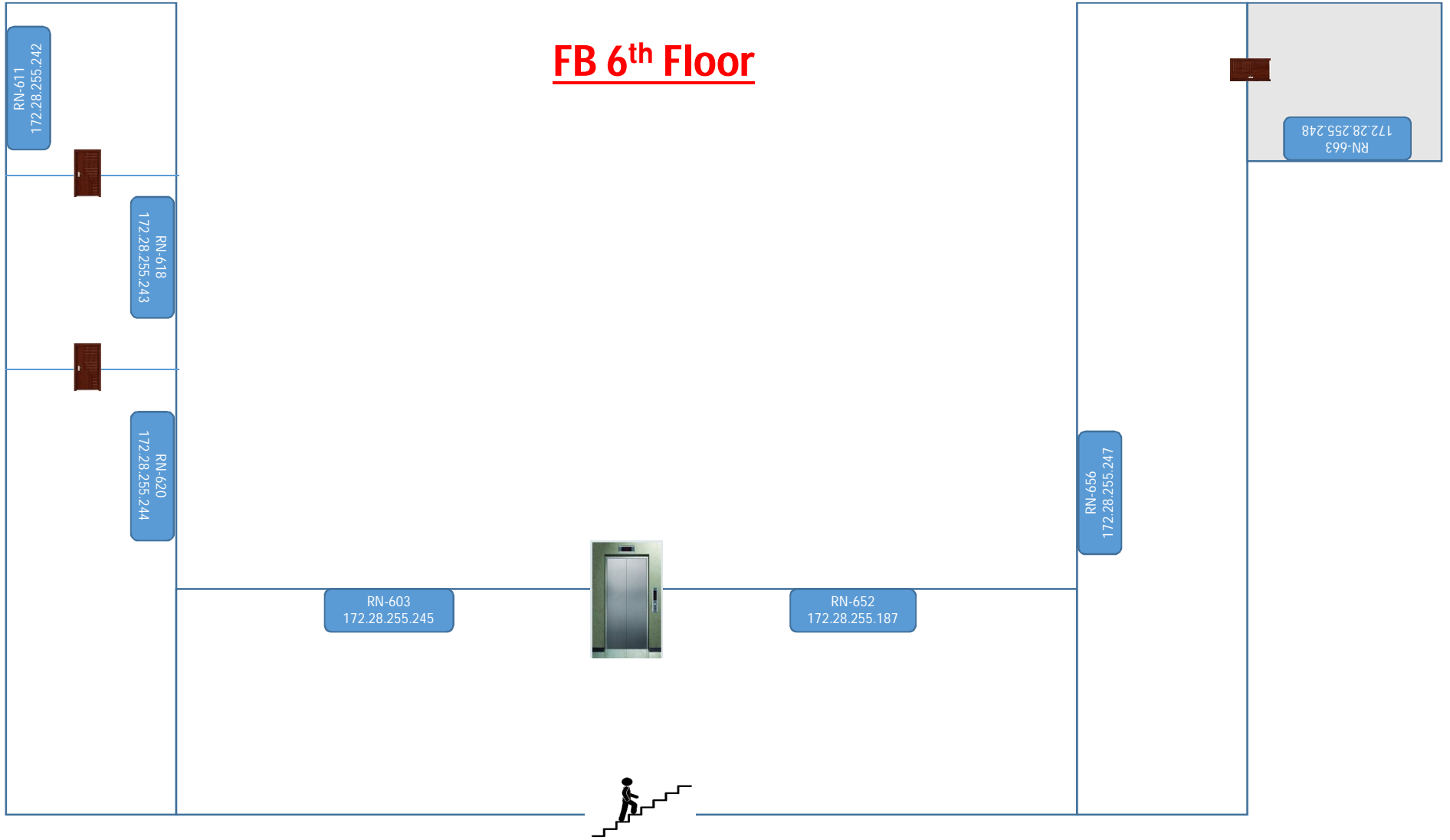

Health Center

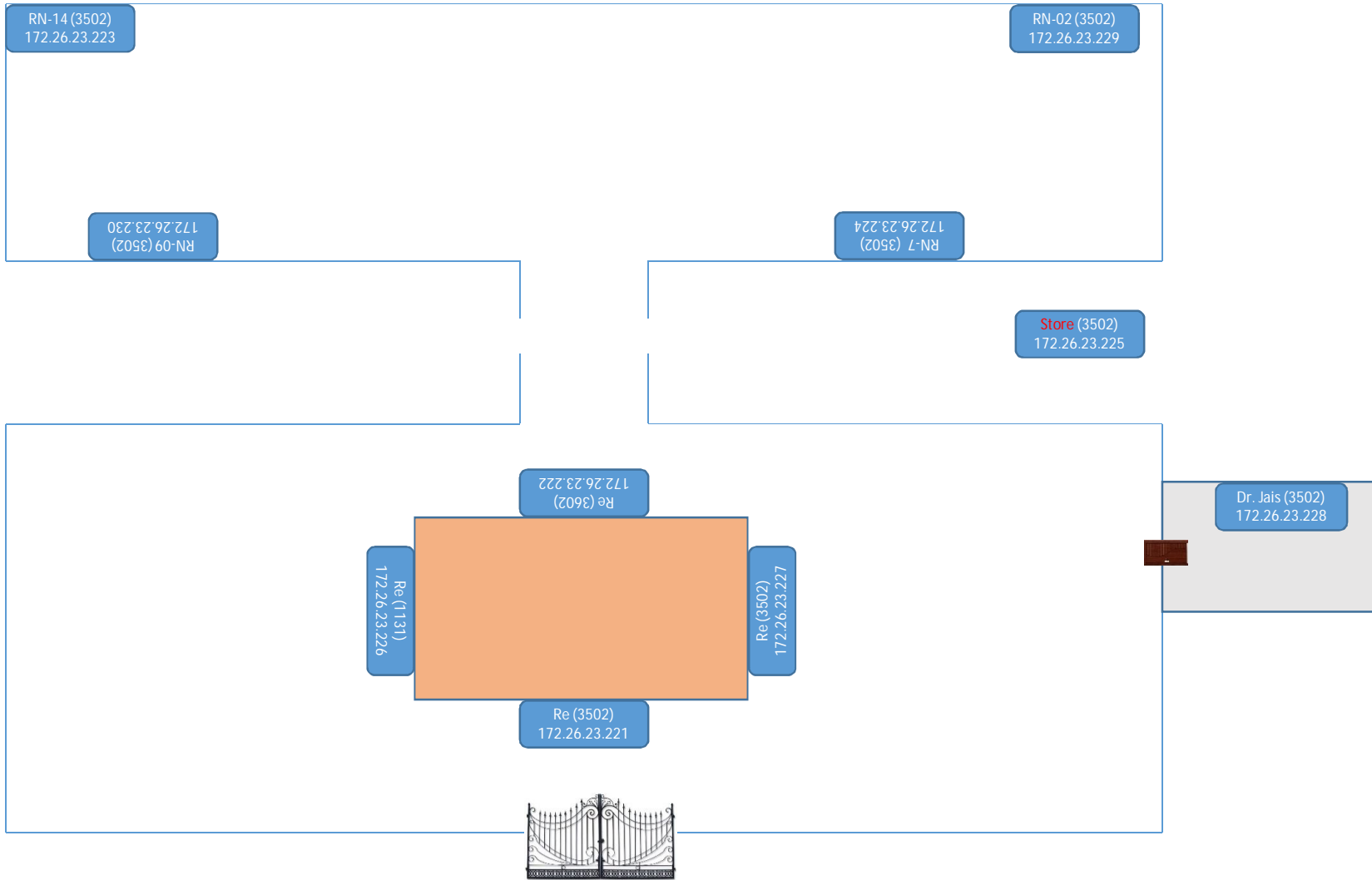

Helicopter GF

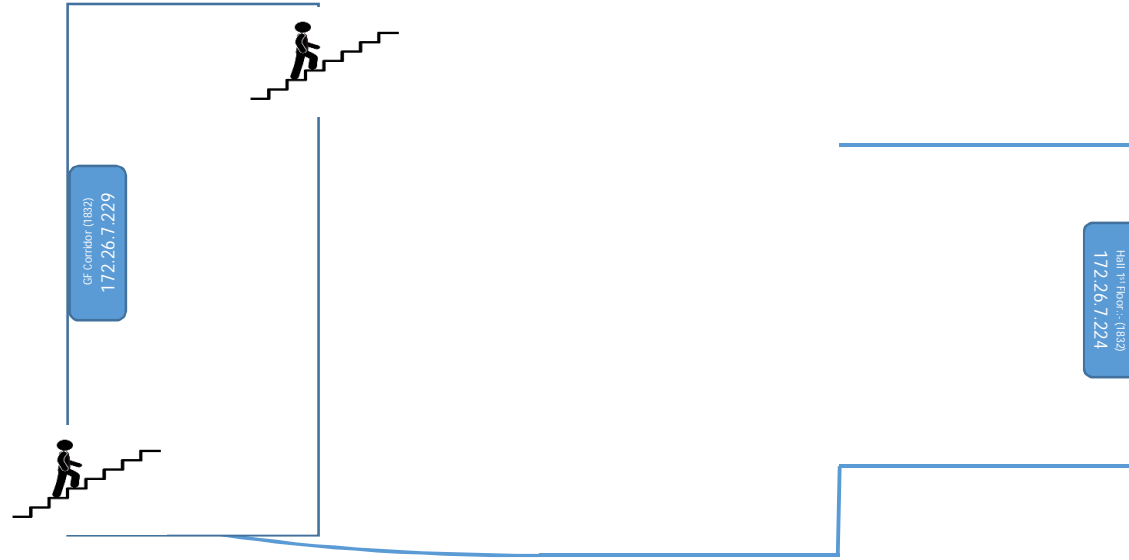
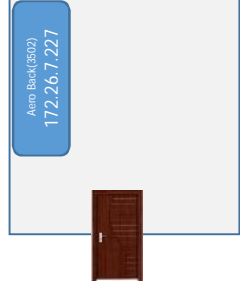

Helicopter 1st F

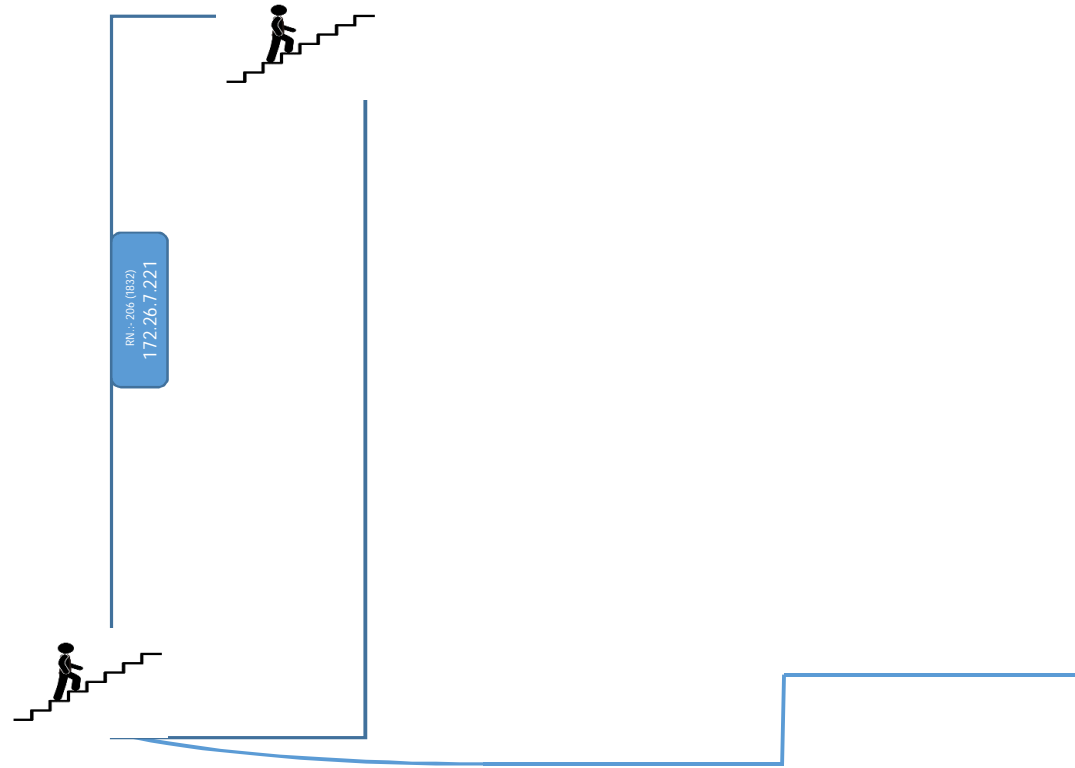

Helicopter 2nd F

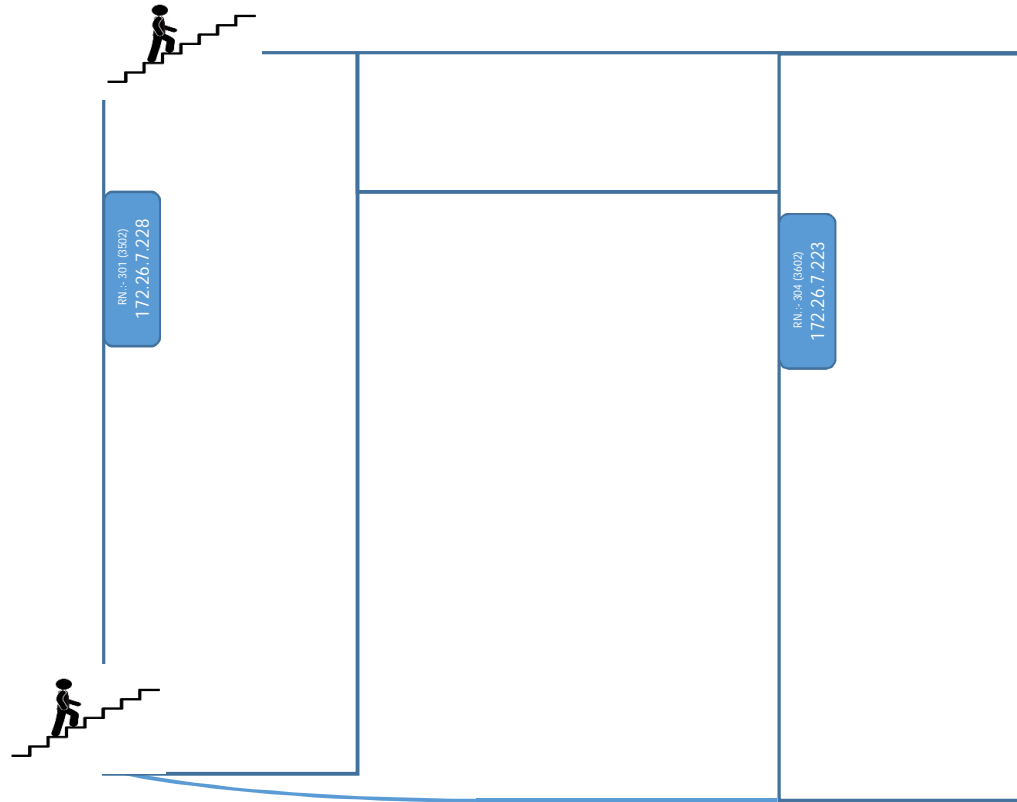

Advance Imaging Lab

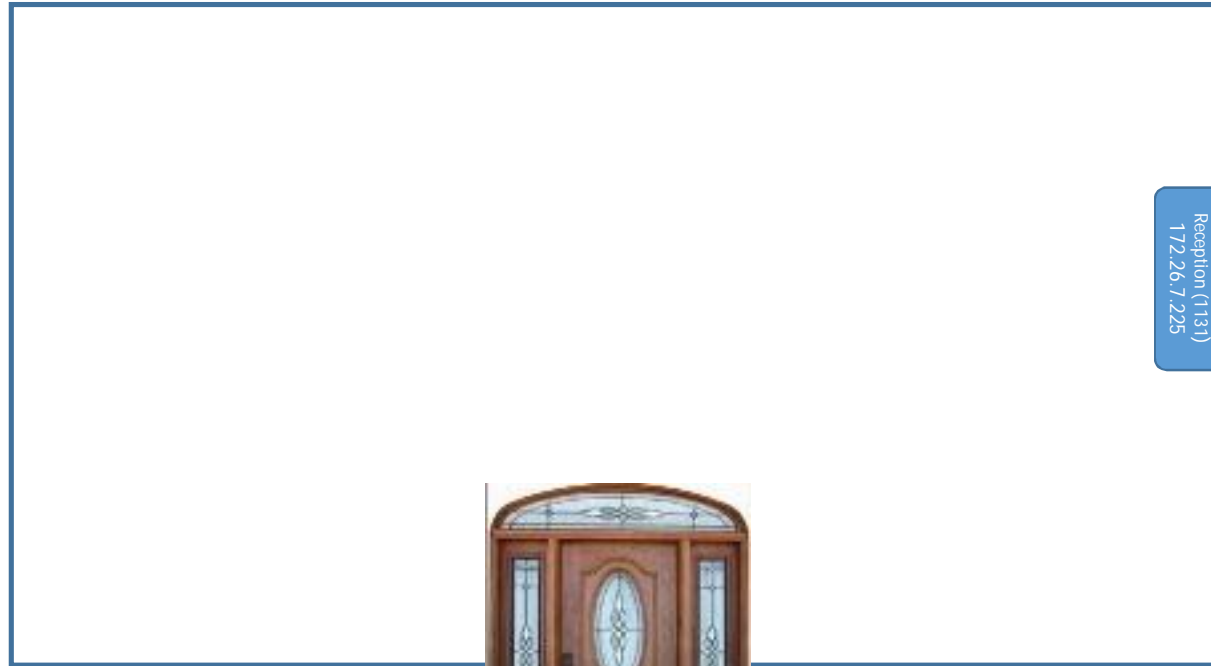

Reception (1131)
172.26.7.225



Advance Imaging Lab

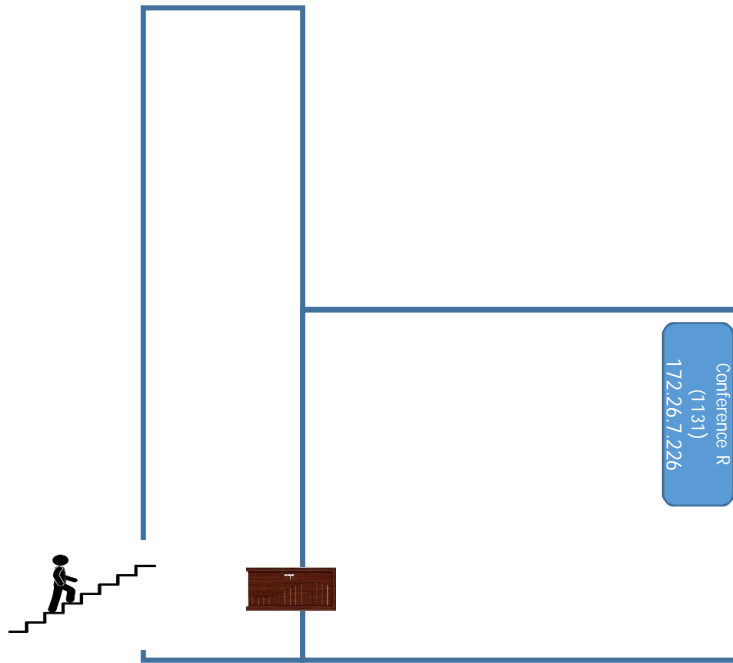

Structure Lab

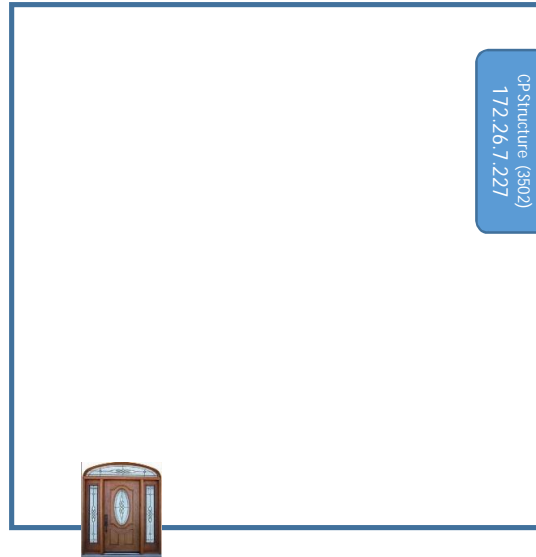

IWD

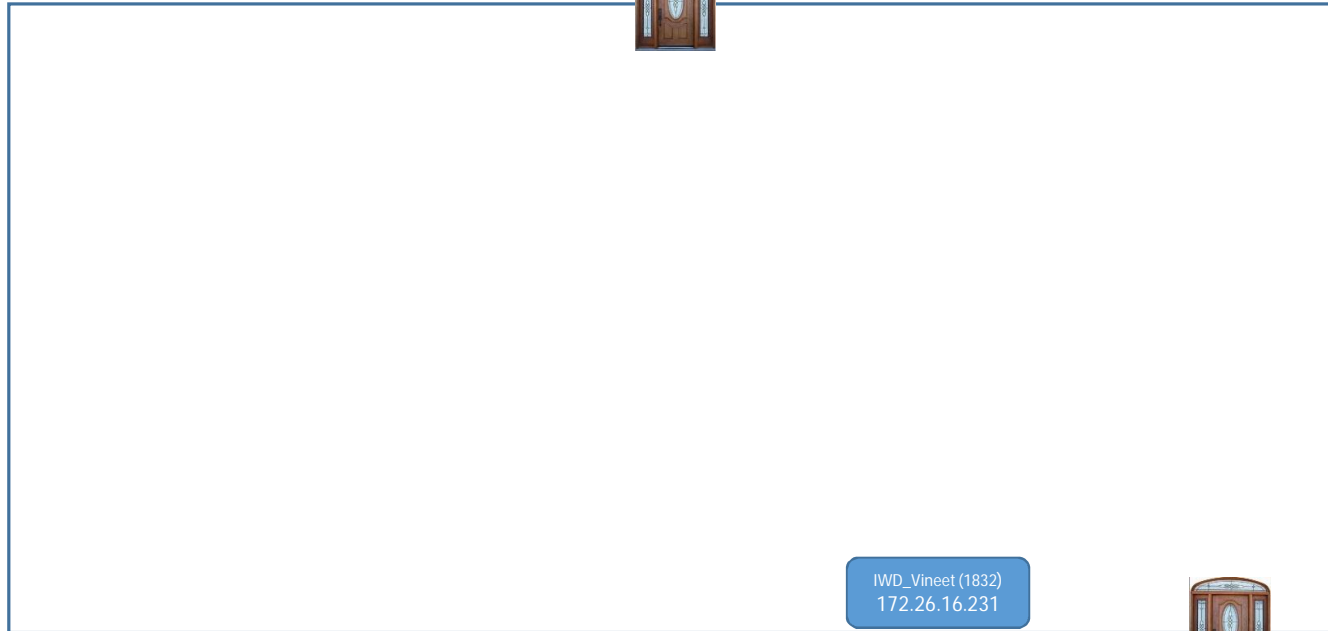

Water Supply IWD (3502)
172.26.19.223

IWD_Vineet (1832)
172.26.16.231



IWD

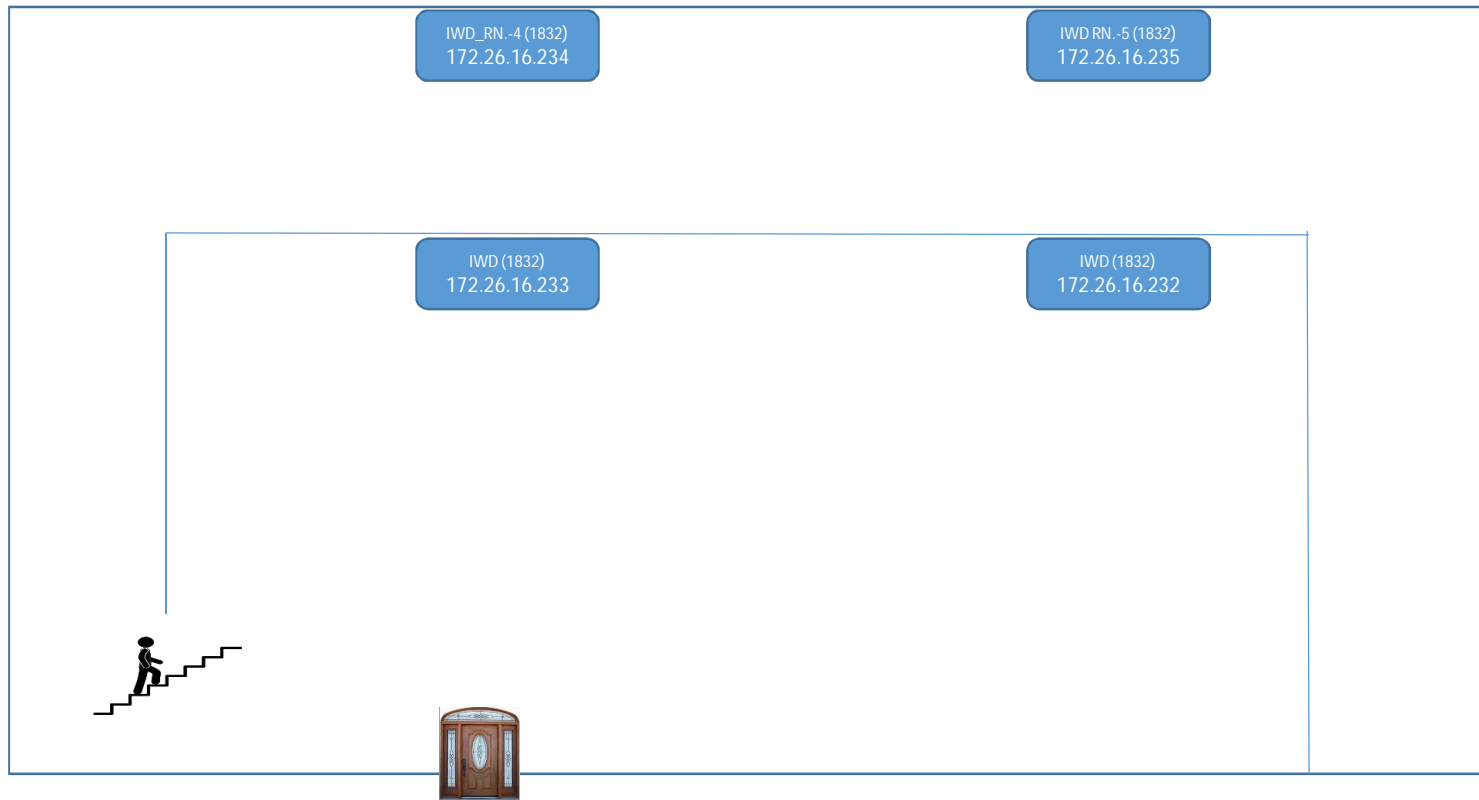

LHC

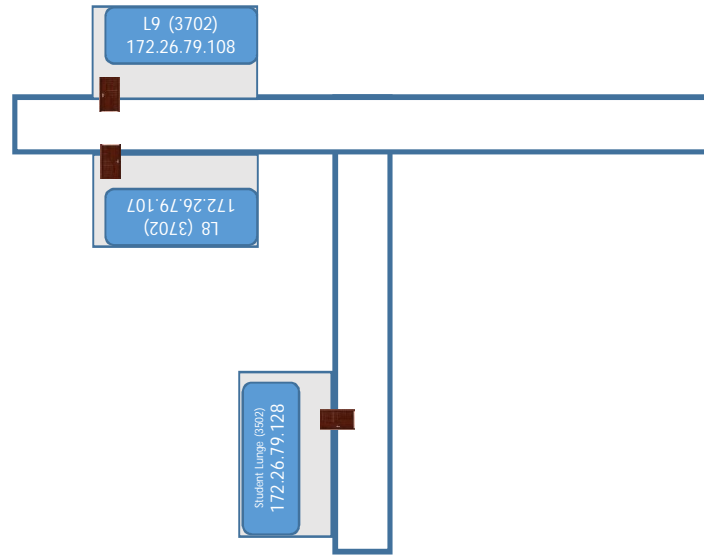
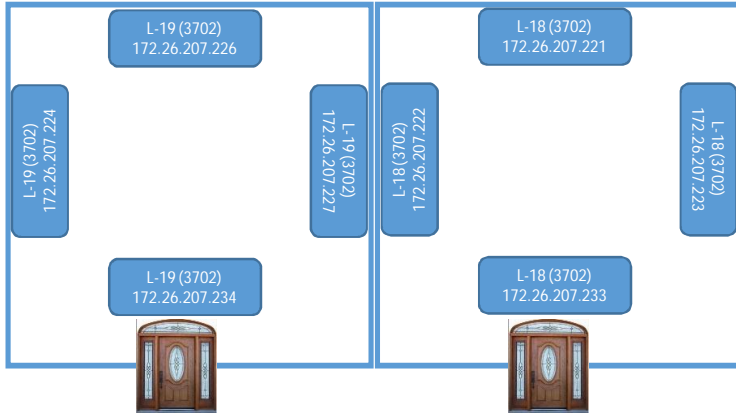
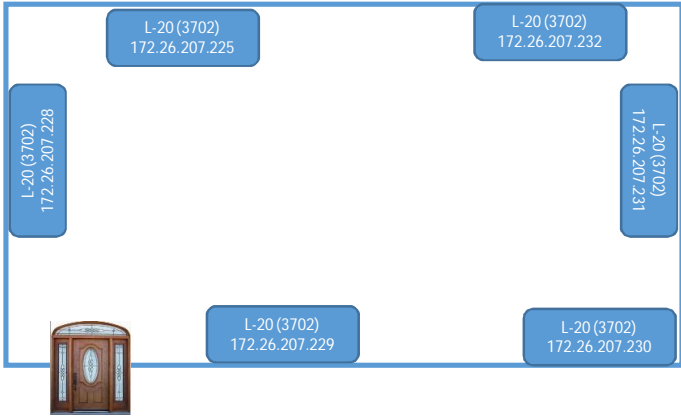

LHC

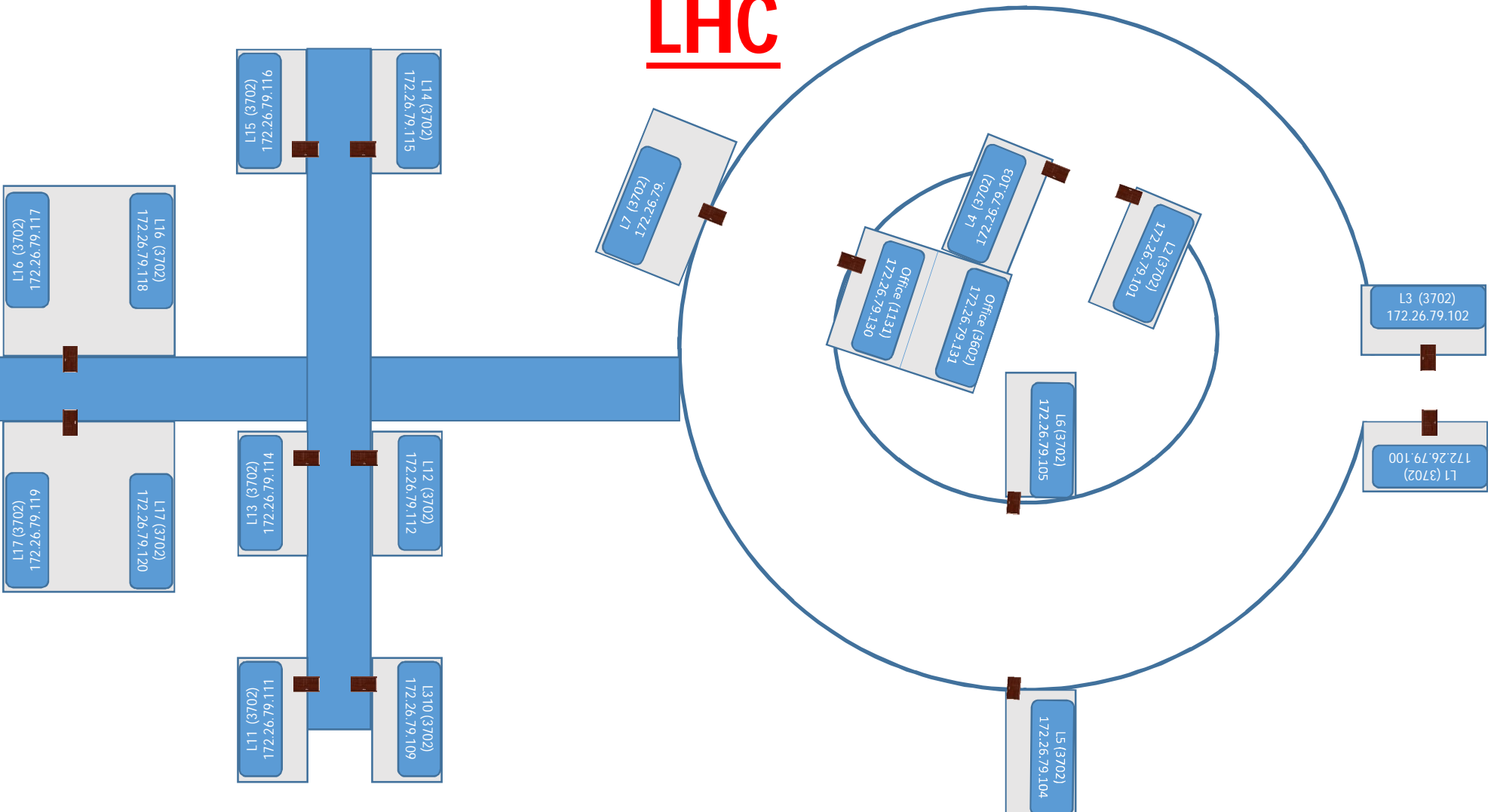

LIBRARY Ground Floor

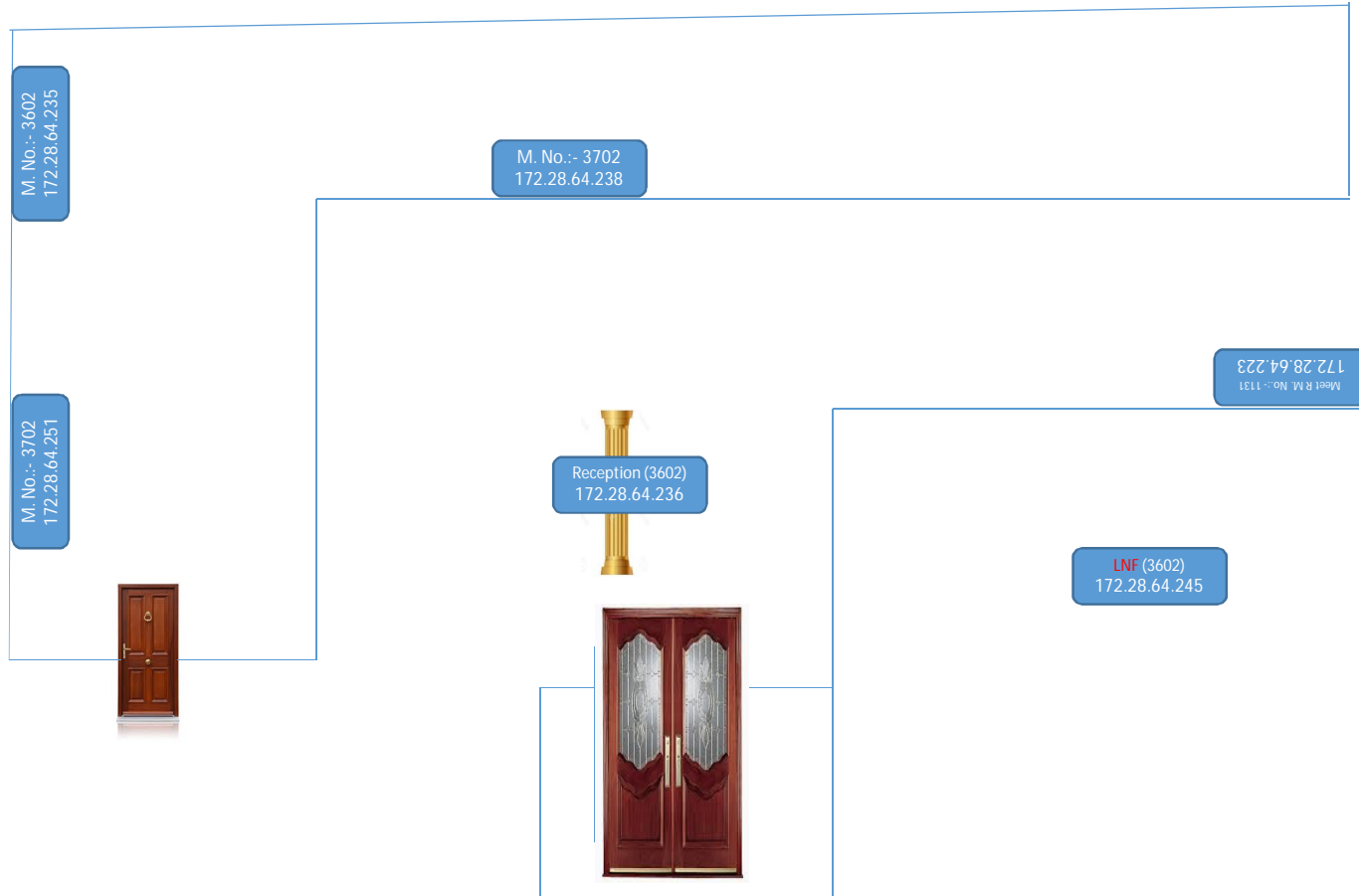

LIBRARY First Floor

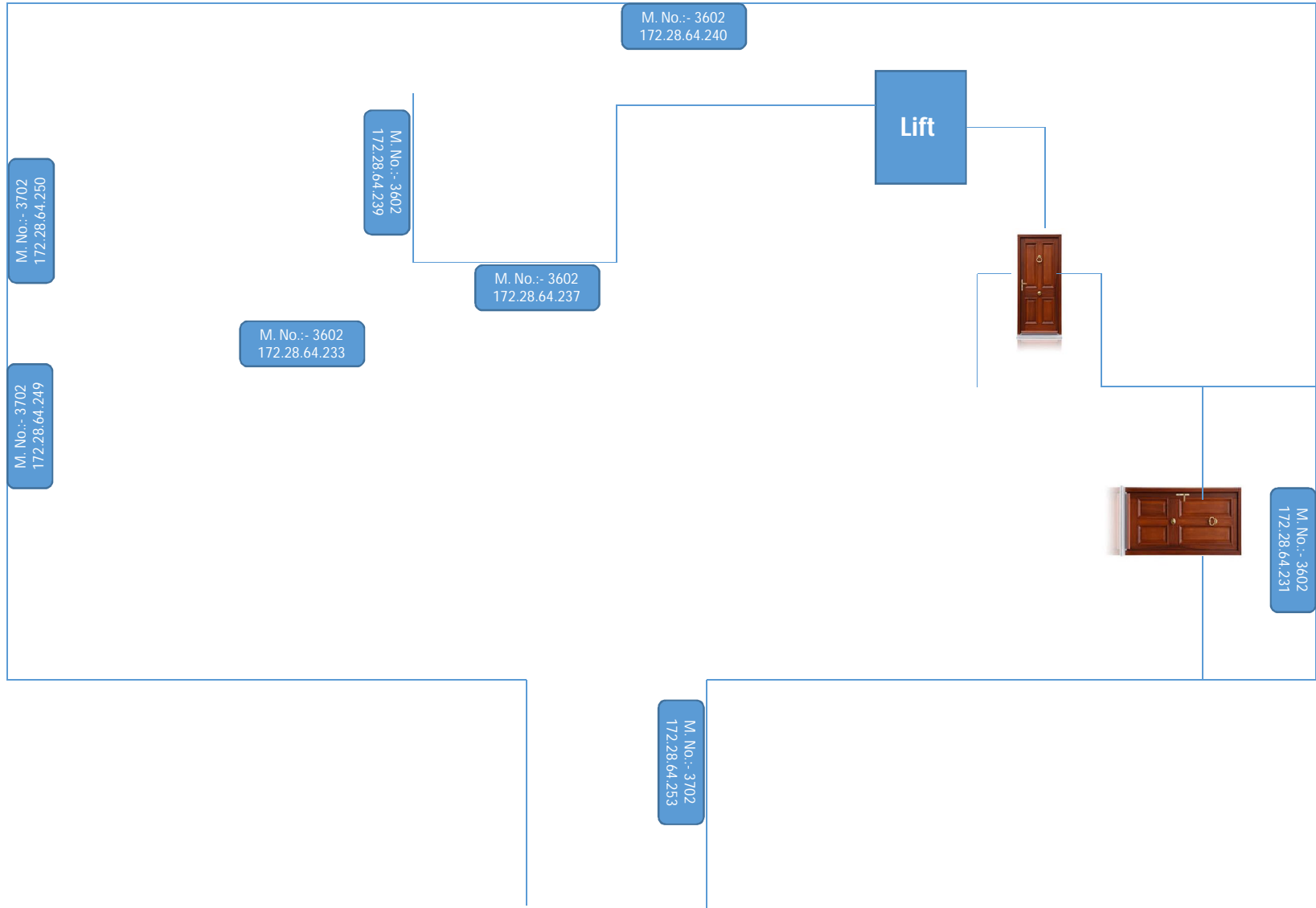

LIBRARY Second Floor

Lift

M. No.:- 3702
172.28.64.246

M. No.:- 3702
172.28.64.247

M. No.:- 3602
172.28.64.243



M. No.:- 3602
172.28.64.232

M. No.:- 3602
172.28.64.241

M. No.:- 3702
172.28.64.222

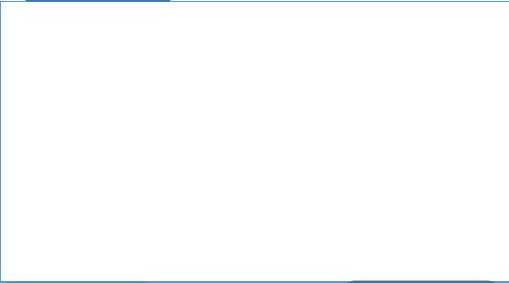

M. No.:- 3702
172.28.64.234

M. No.:- 3602
172.28.64.244

M. No.:- 3702
172.28.64.248

M. No.:- 3602
172.28.64.245

M. No.:- 3602
172.28.64.230

M. No.:- 3602
172.28.64.221

M. No.:- 3702
172.28.64.253



New Core Lab 1st Floor

RN-103 (3502)
172.26.123.222

RN-104 (3502)
172.26.123.221

RN-105 (3602)
172.26.123.234

RN-103 (3502)
172.26.123.223

RN-106 (3502)
172.26.123.230

RN-101 (3502)
172.26.123.224

RN-107 (3502)
172.26.123.229

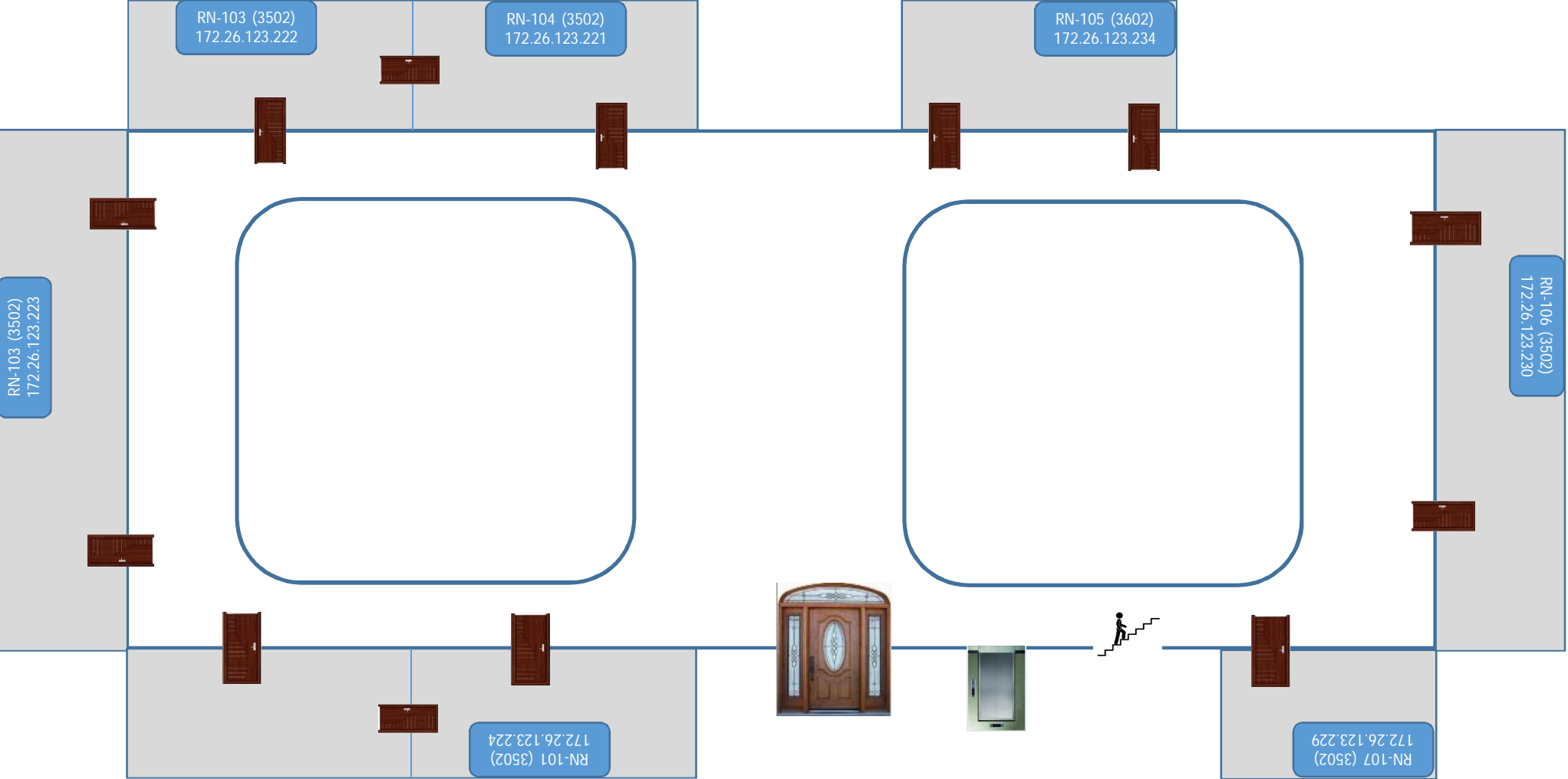

New Core Lab 2nd Floor

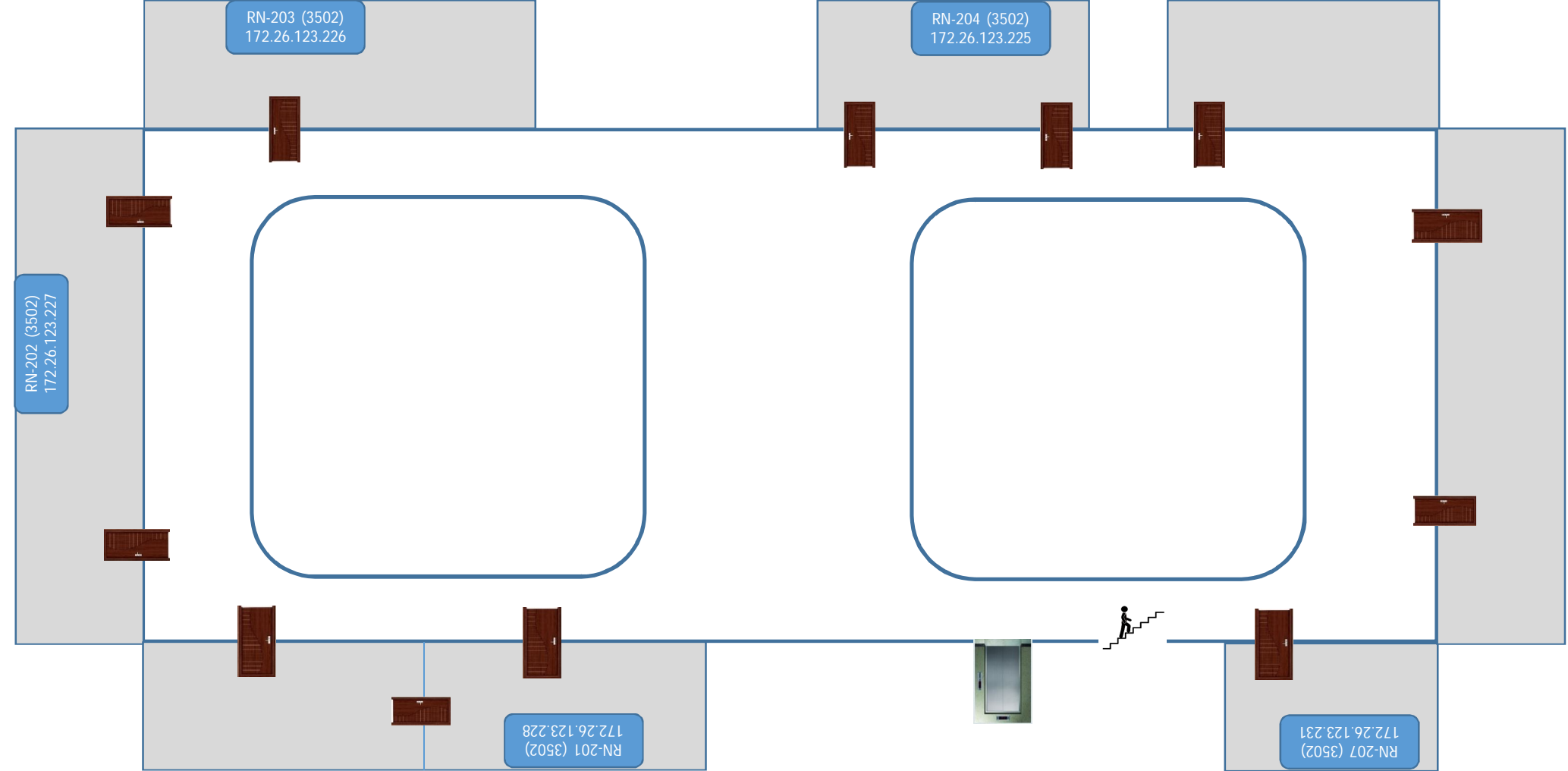

New Core Lab 3rd Floor

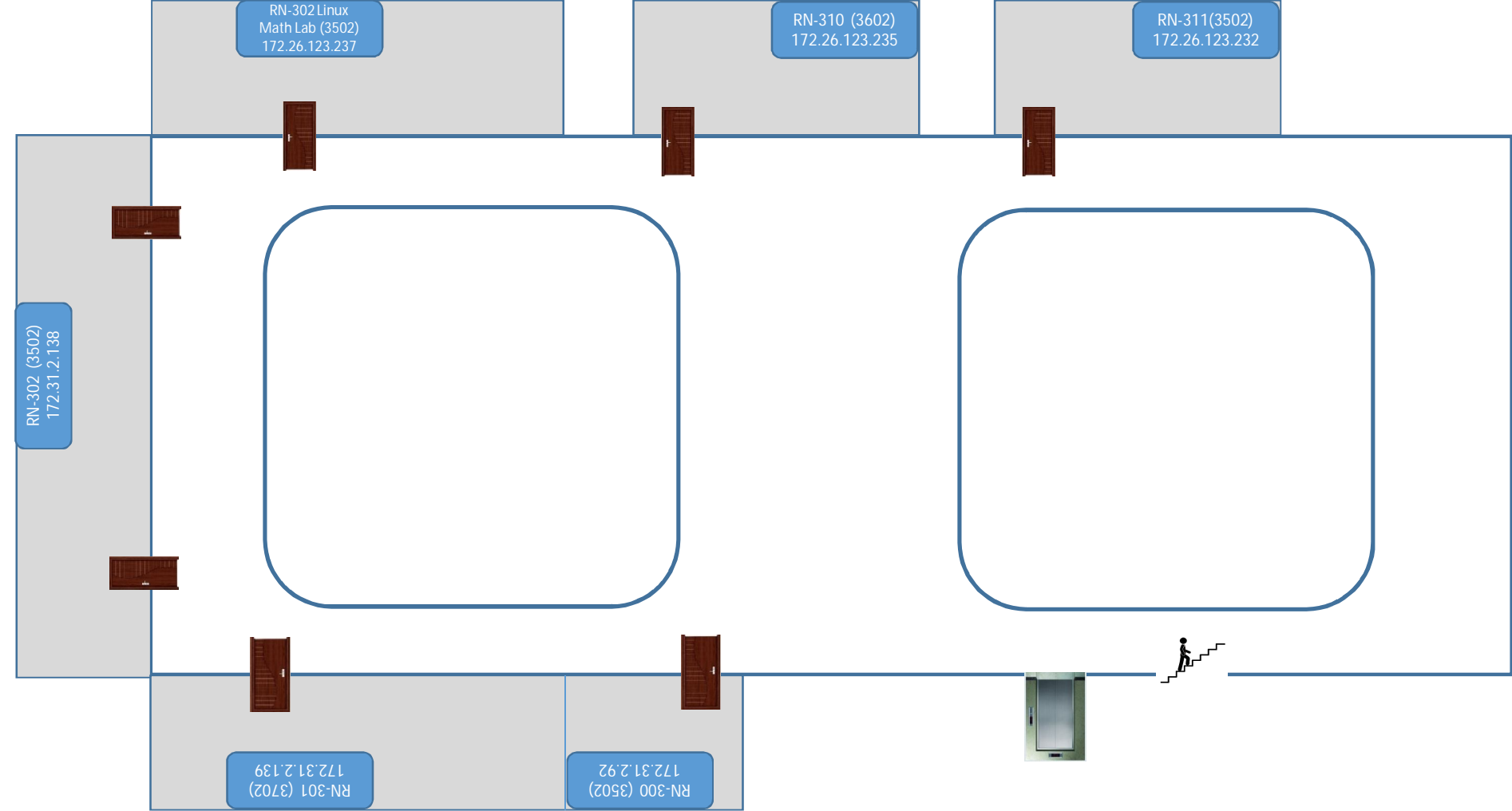

NEW IME 1st Floor

RN-104 (3502)
172.26.155.221



Main Door(3502)
172.26.155.234



RN-C1 (3502)
172.26.155.230



New IME2nd Floor

RN-209 (3502)
172.26.155.224



RN-208 (3502)
172.26.155.222

RN-202 (3502)
172.26.155.223

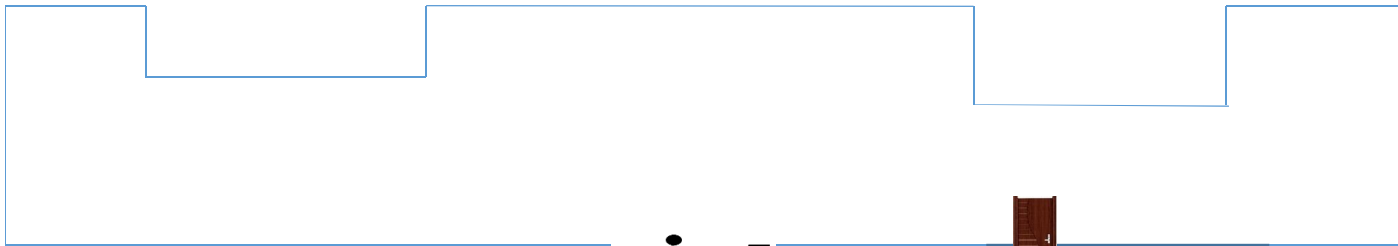

RN-C2 (3502)
172.26.155.229

New IME 3rd Floor

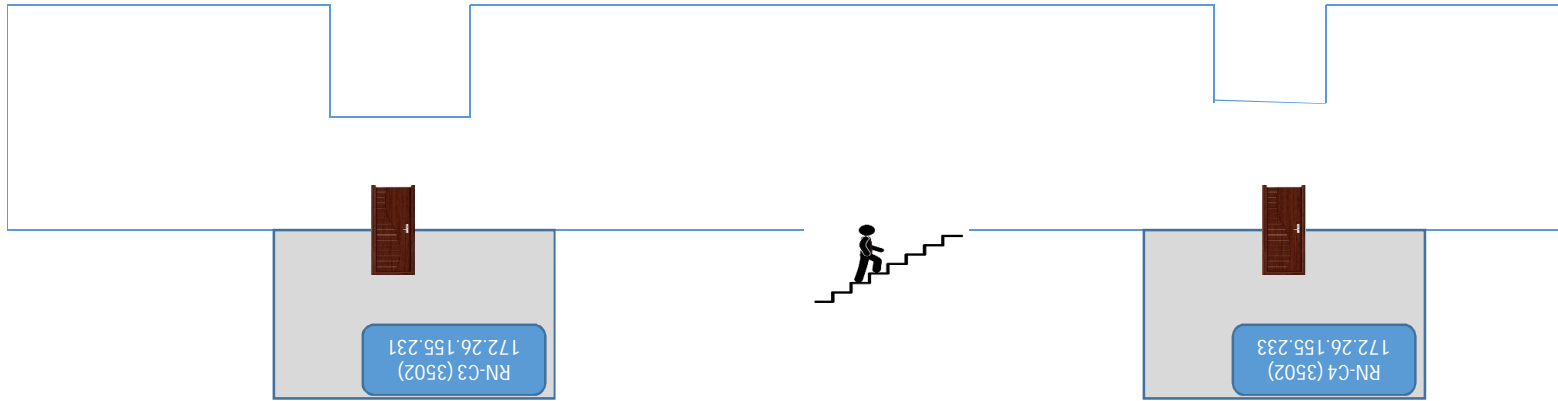
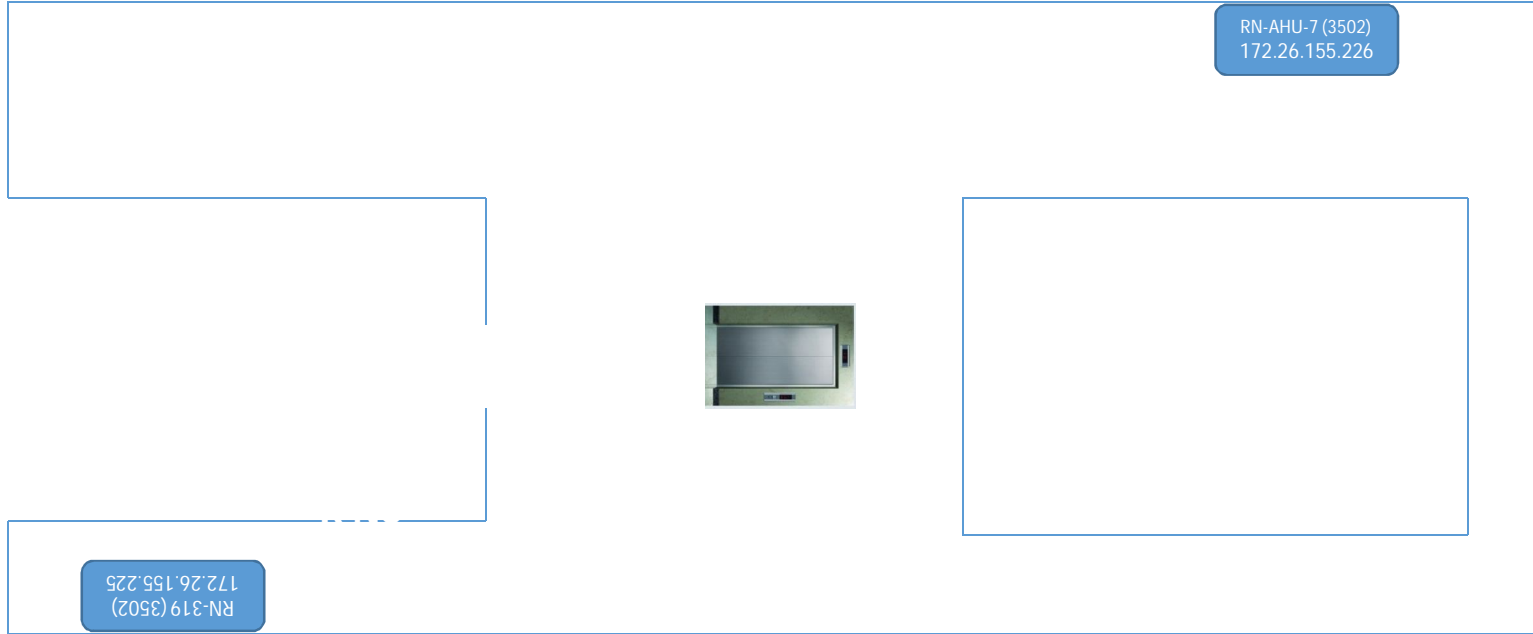

New IME 4th Floor

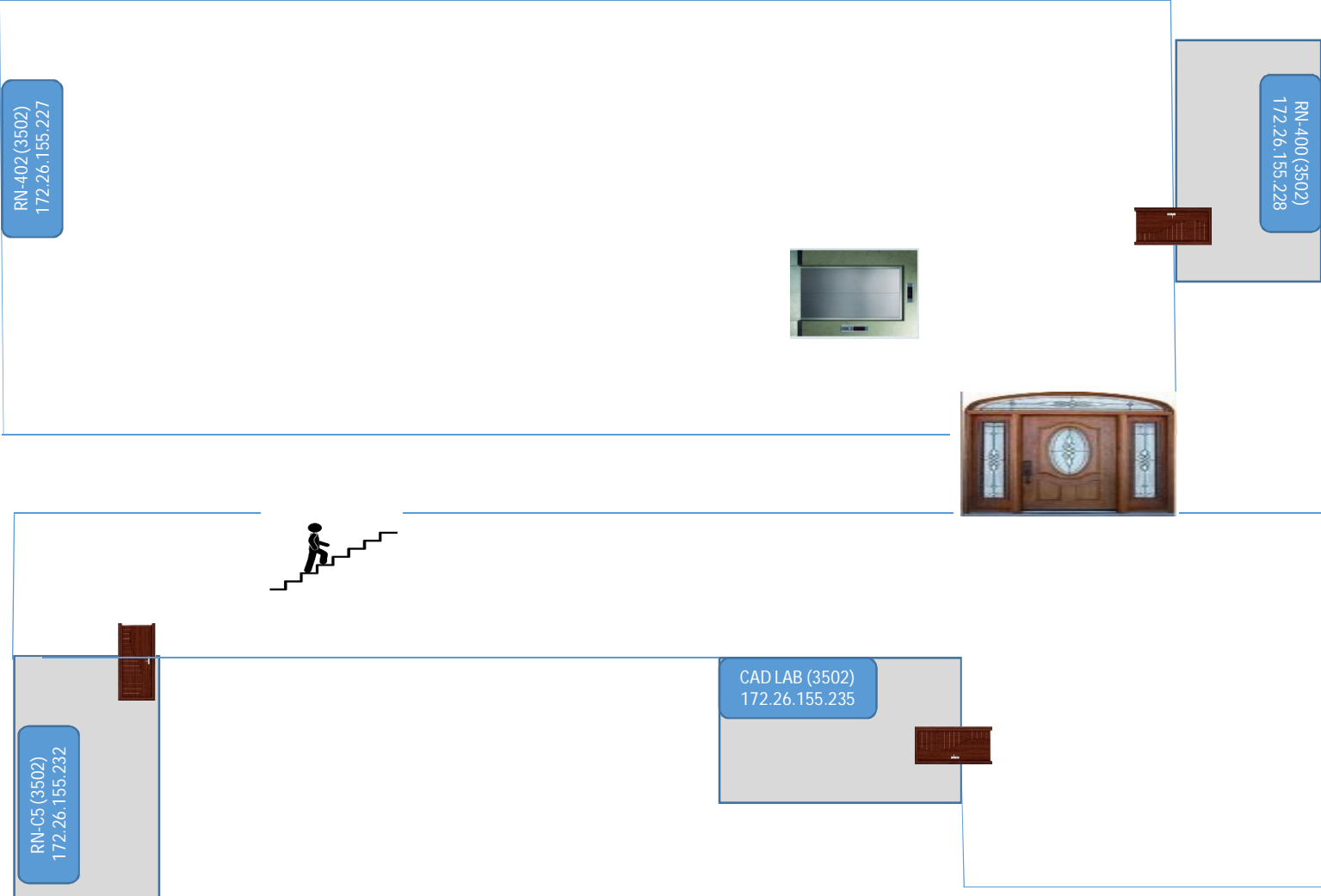

RN-402 (3502)
172.26.155.227

RN-400 (3502)
172.26.155.228

RN-C5 (3502)
172.26.155.232

CAD LAB (3502)
172.26.155.235

NL-1 1st Floor

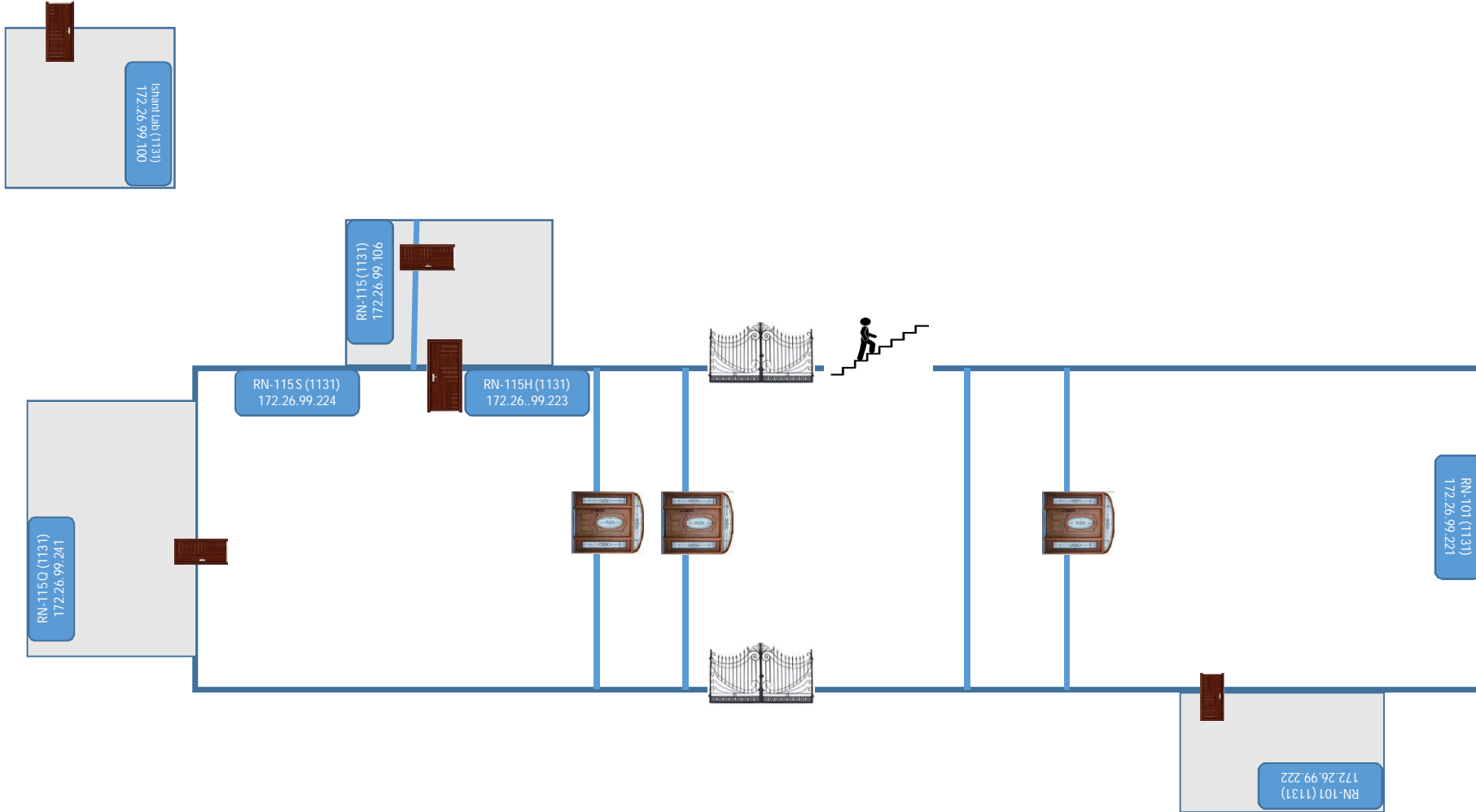

NL-1 2nd Floor

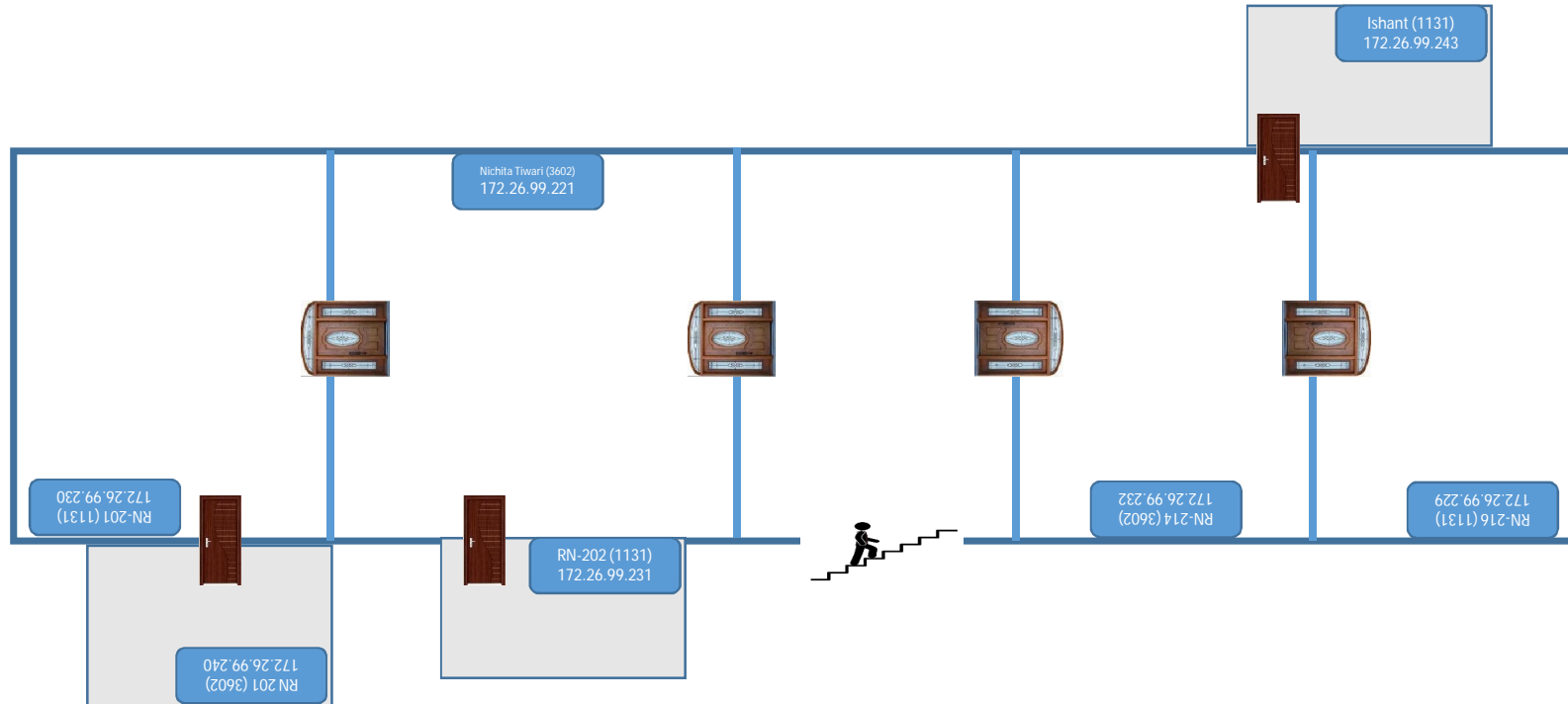

NL-1 3rd Floor

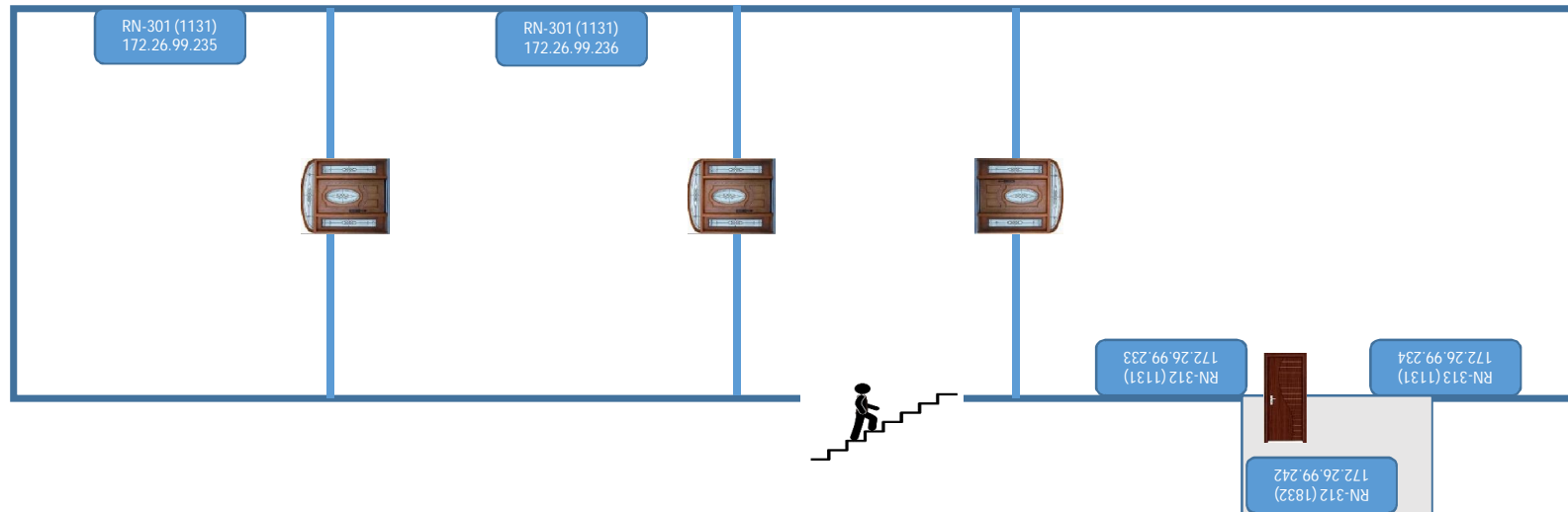

Nuclear Lab 1st Floor

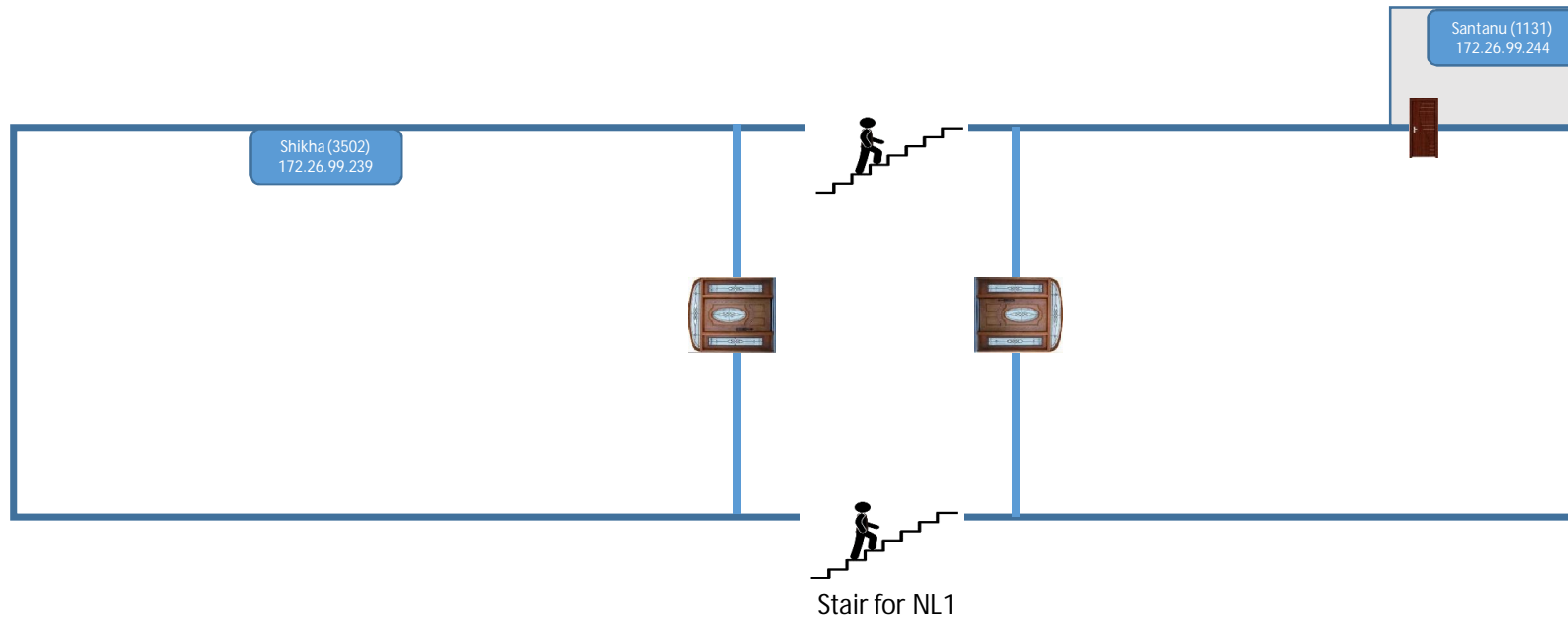

Nuclear Lab 2nd Floor

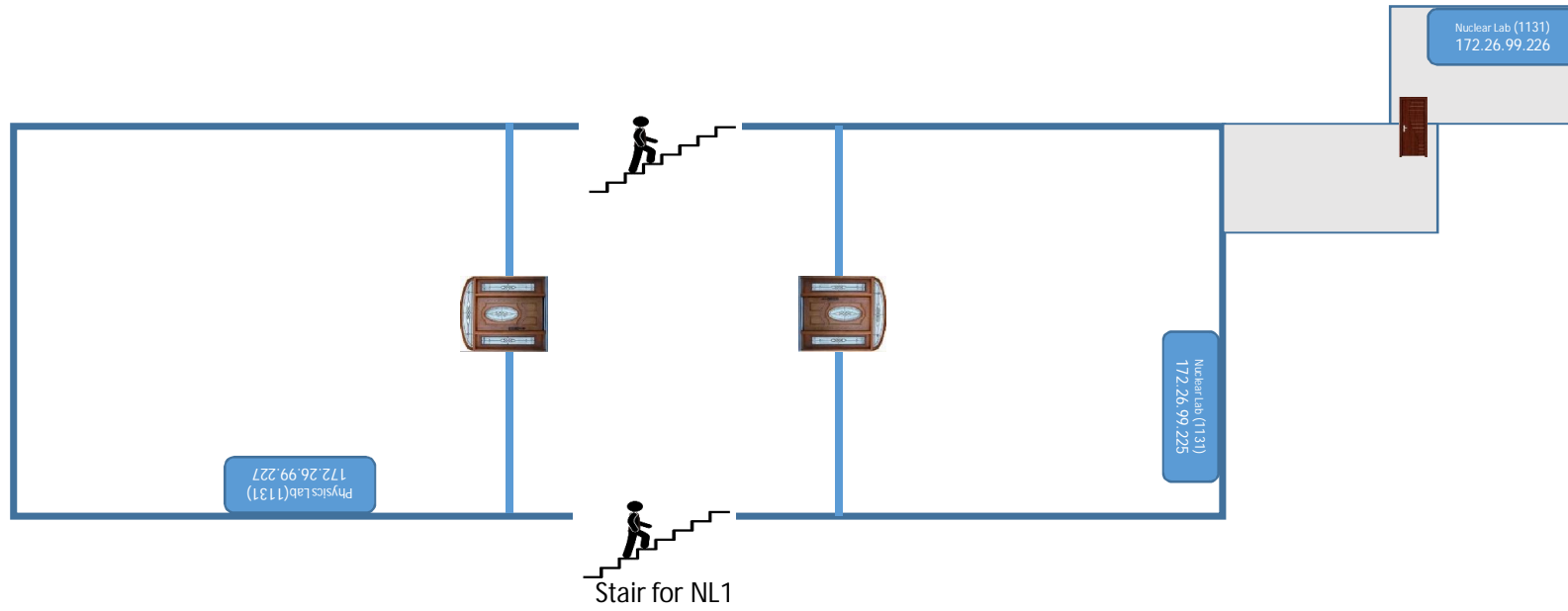

NL-2 G Floor

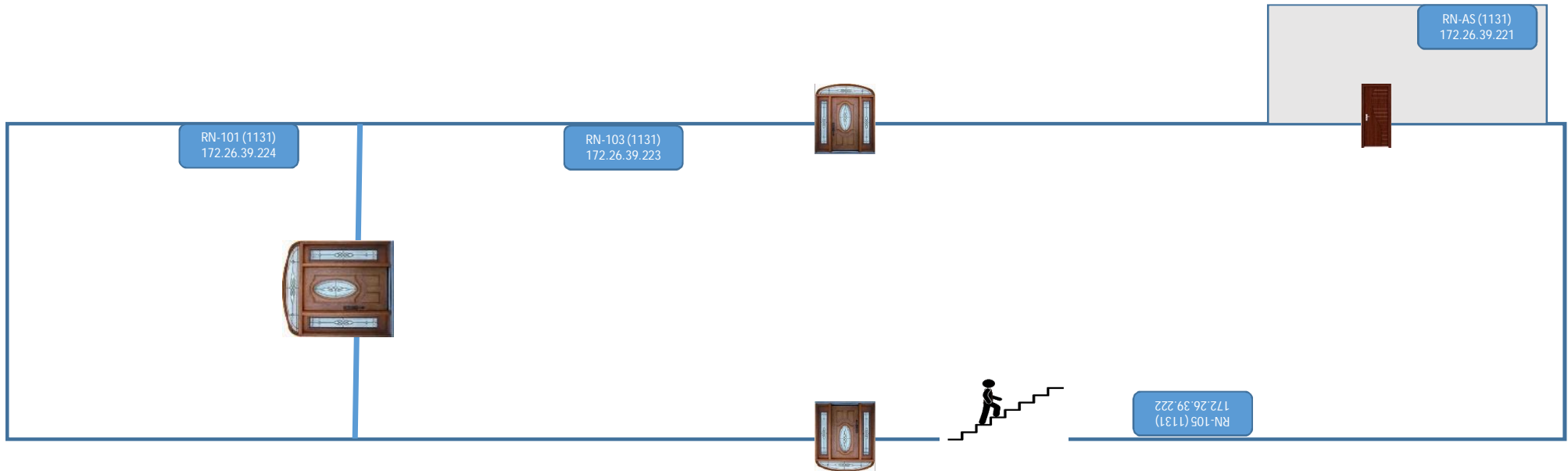

NL-2 1st Floor

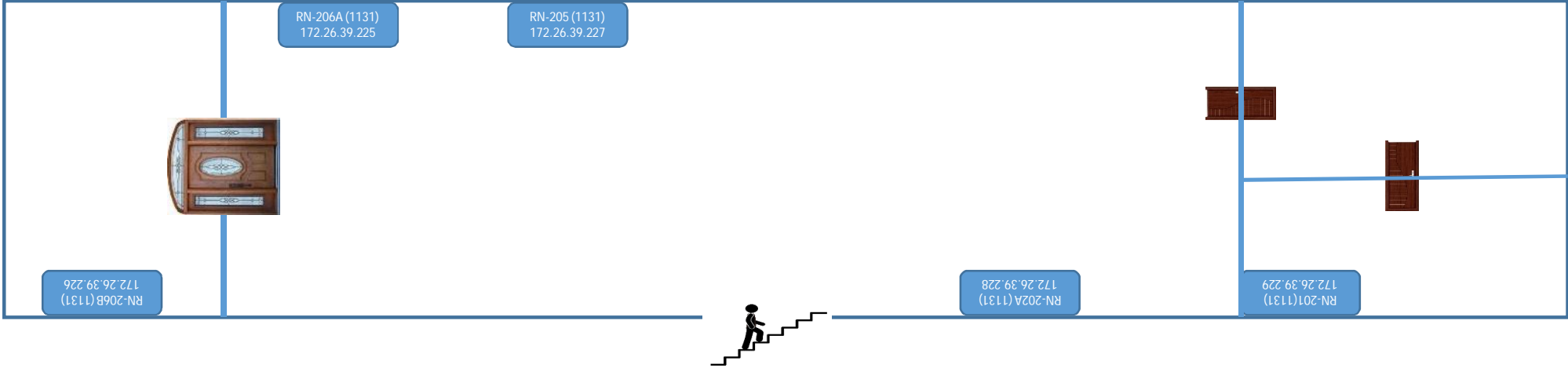

NL-2 2nd Floor

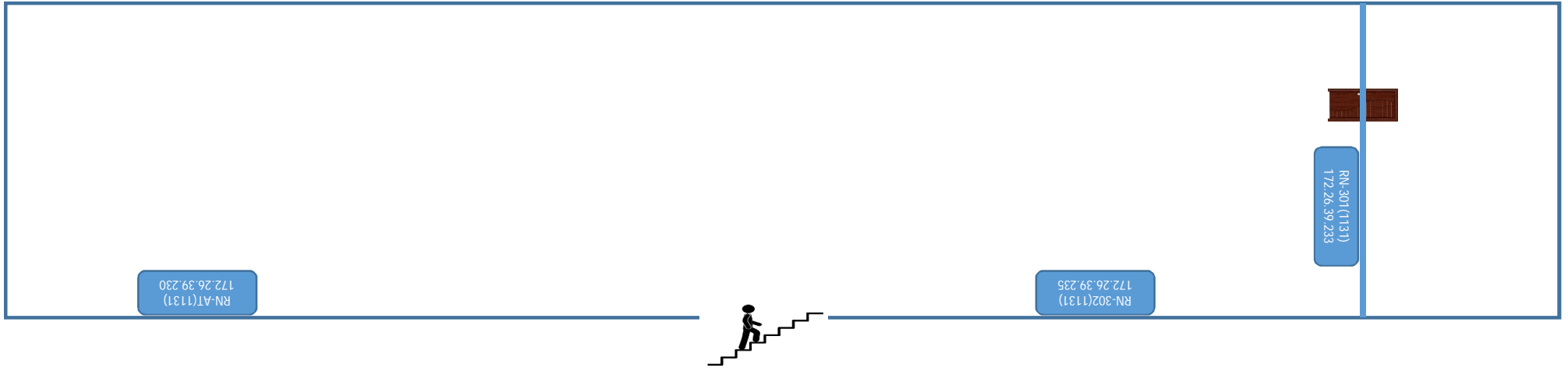

Nano Science GF

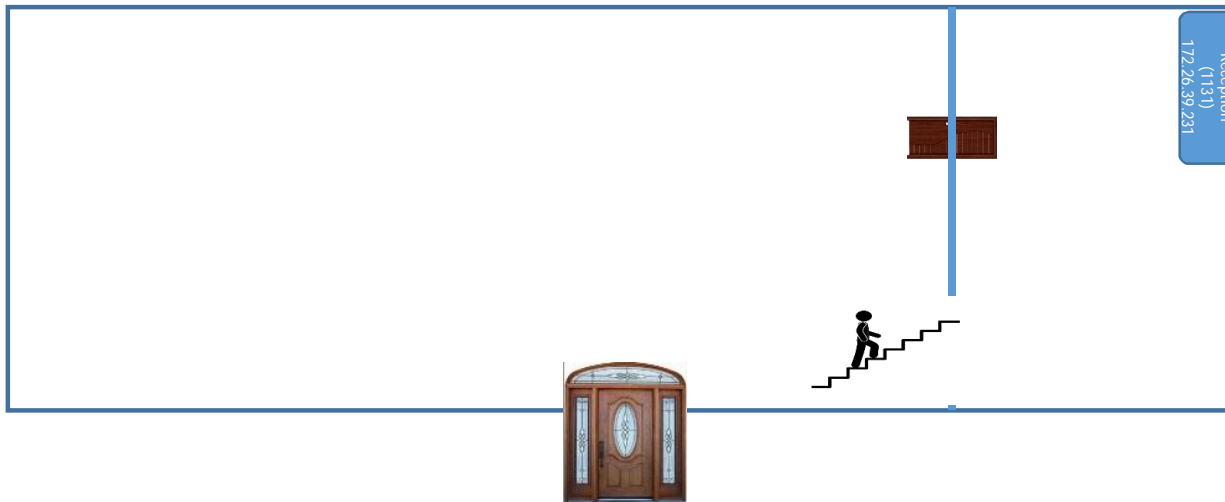

Nano Science 1st F

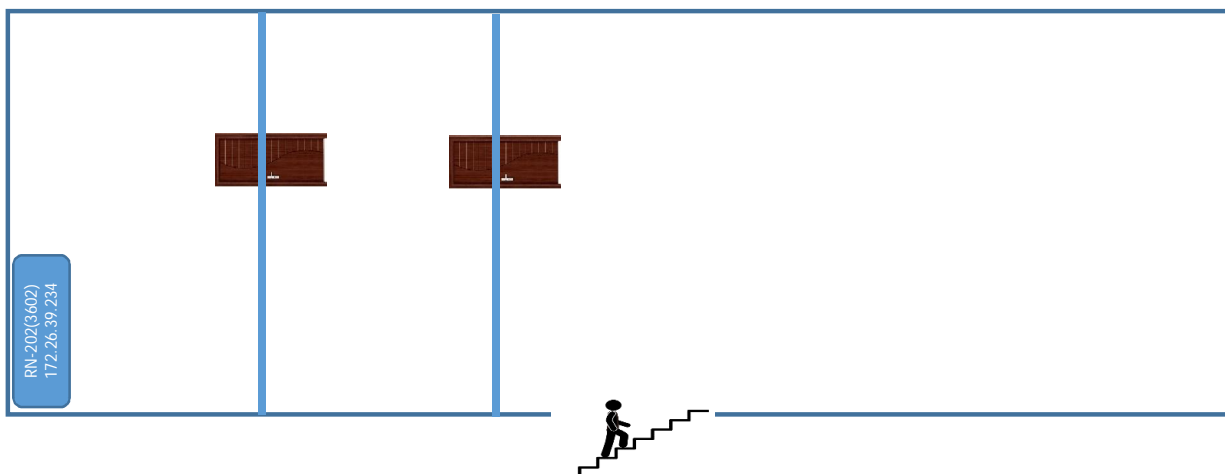

NWTF GF

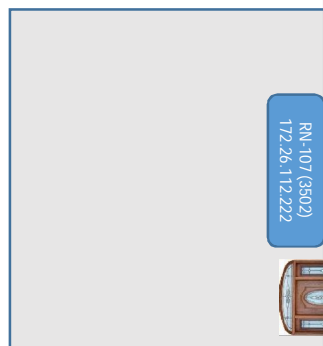

NWTF 1st Floor

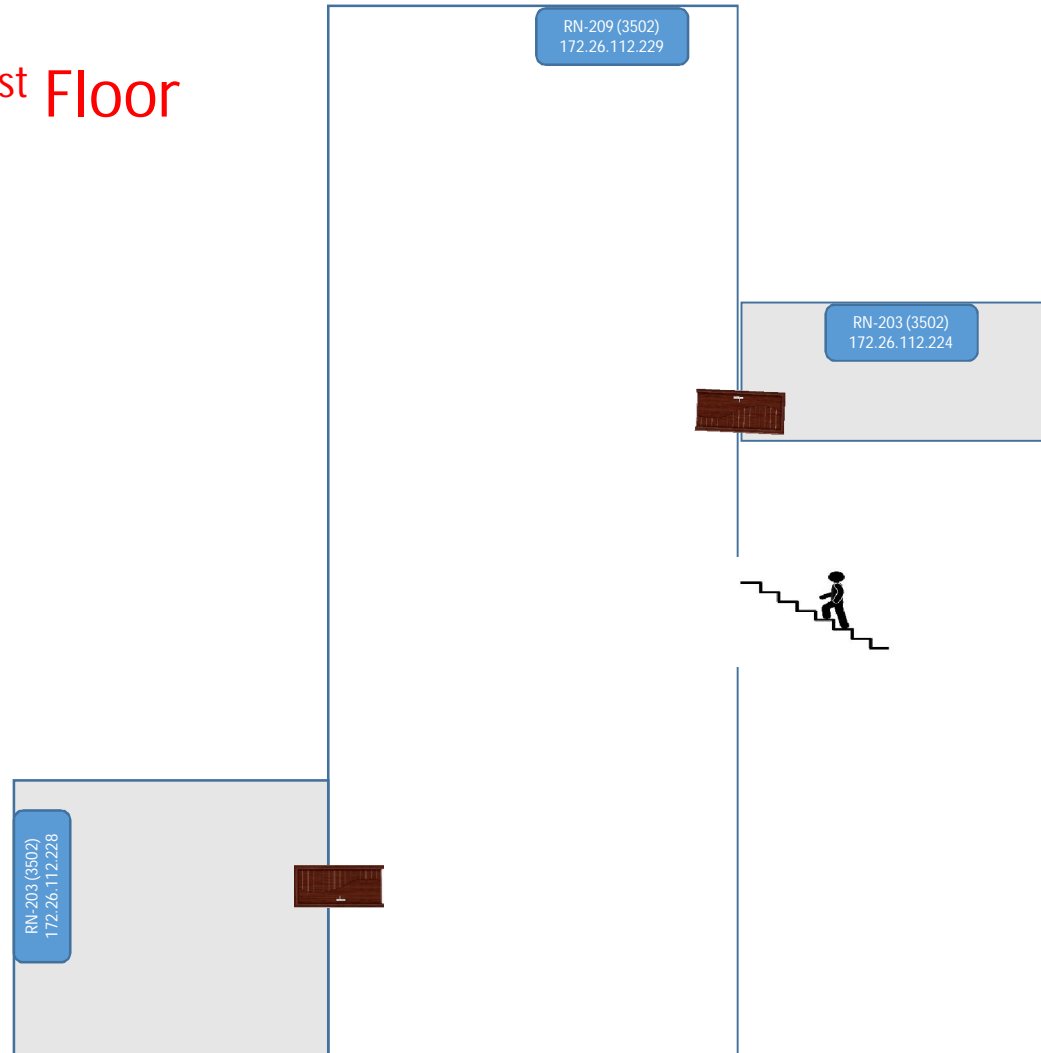

NWTF 2nd Floor

RN-305 (3602)
172.26.112.226



CR (3502)
172.26.112.221

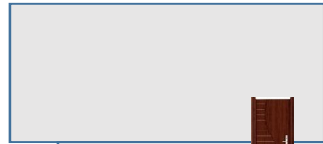

RN-302 (1131)
172.26.112.225

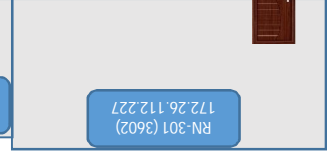

RN-301 (3602)
172.26.112.227



OCL GF

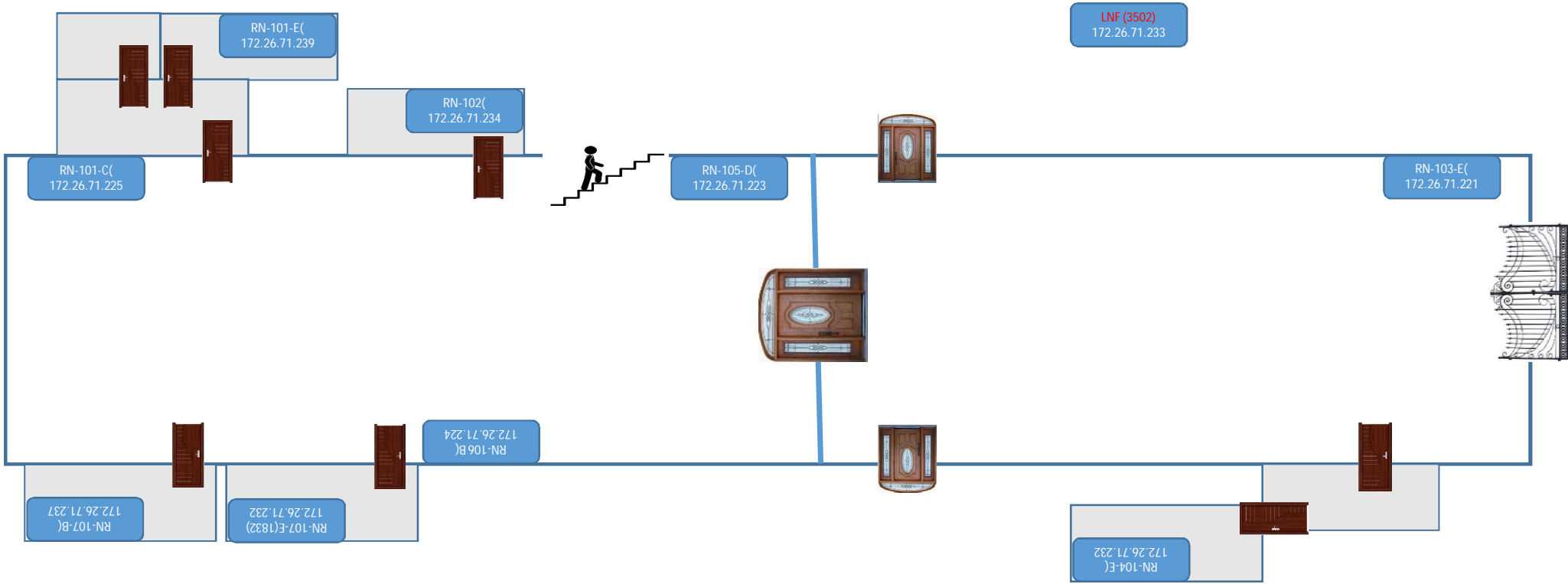

OCL 1st Floor

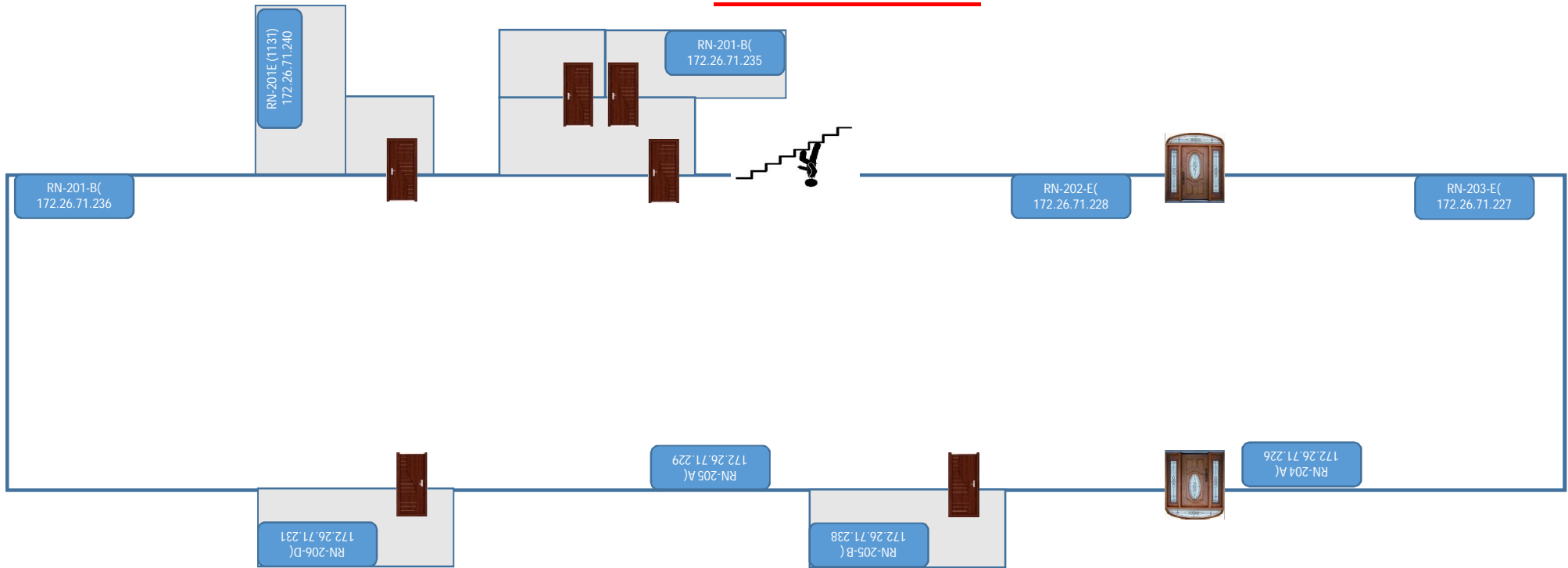

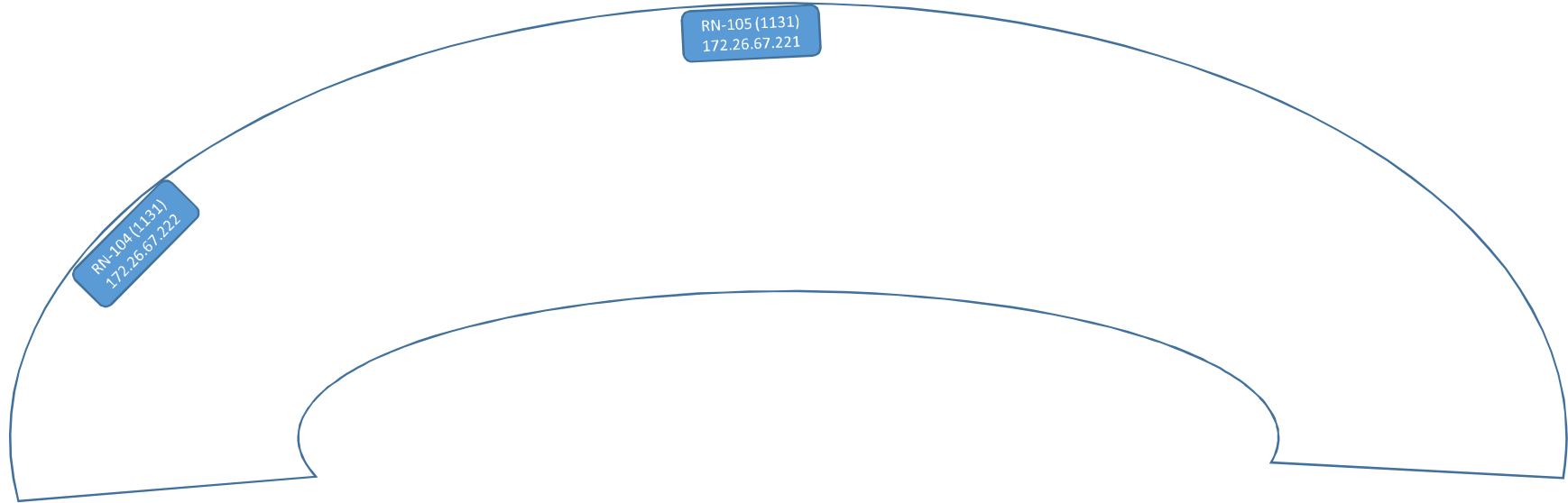

SAMTEL 1st Floor

LNF (1131)
172.26.67.226

RN-204 (1131)
172.26.67.223

SAMTEL 2nd Floor

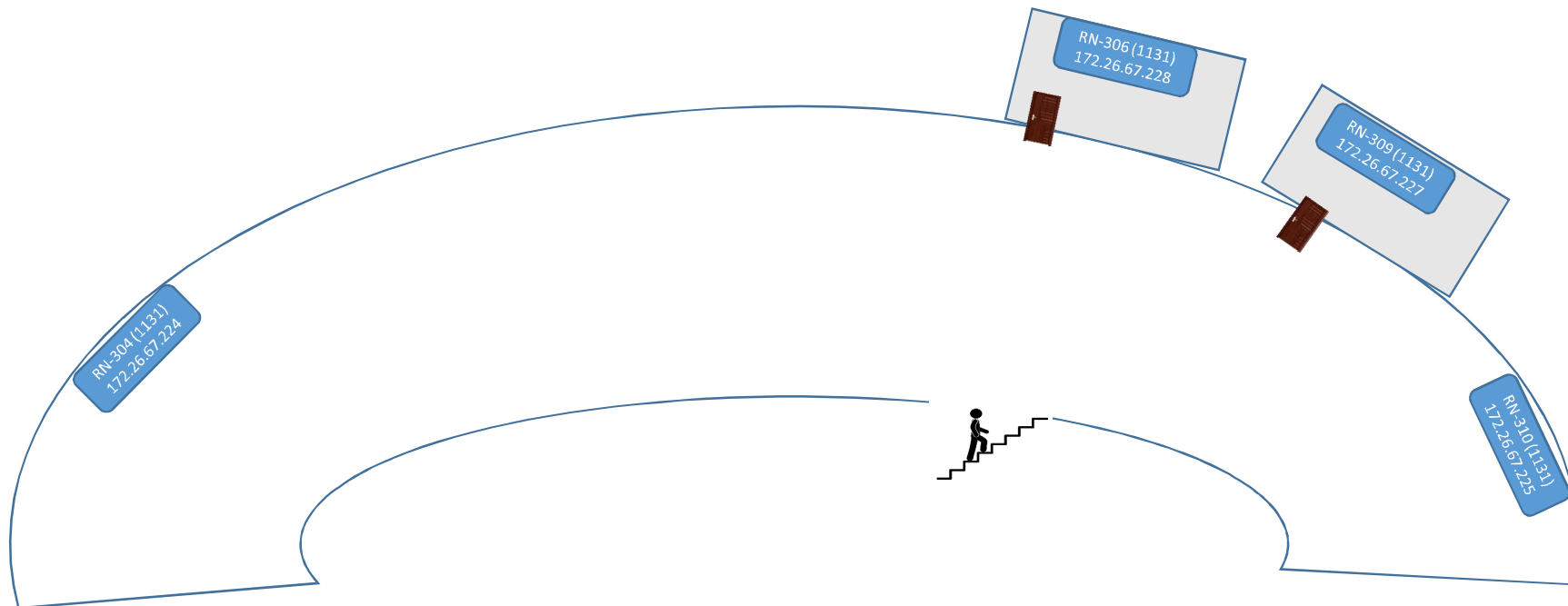

SAMTEL 3rd Floor

SIDBI

First Floor

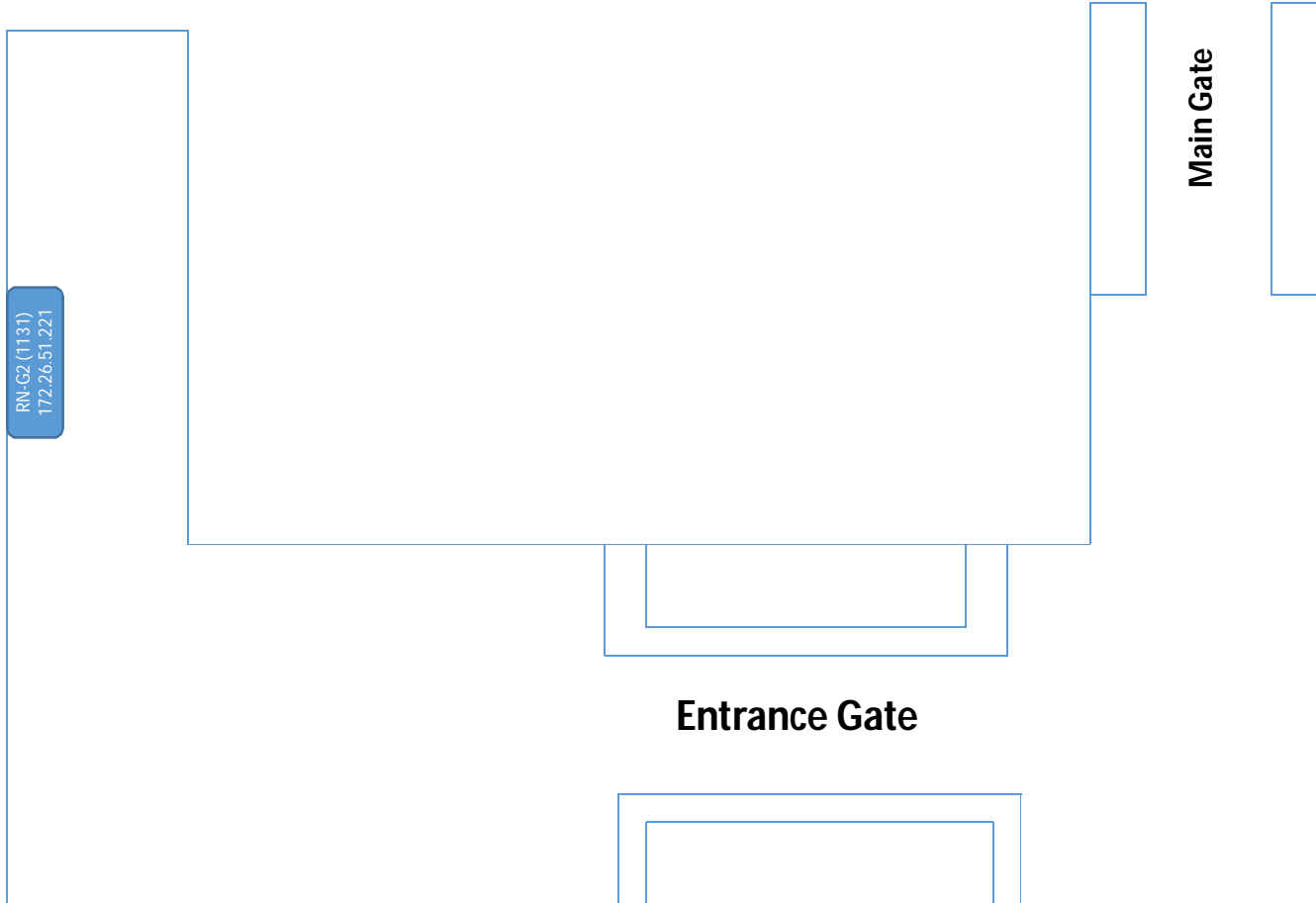

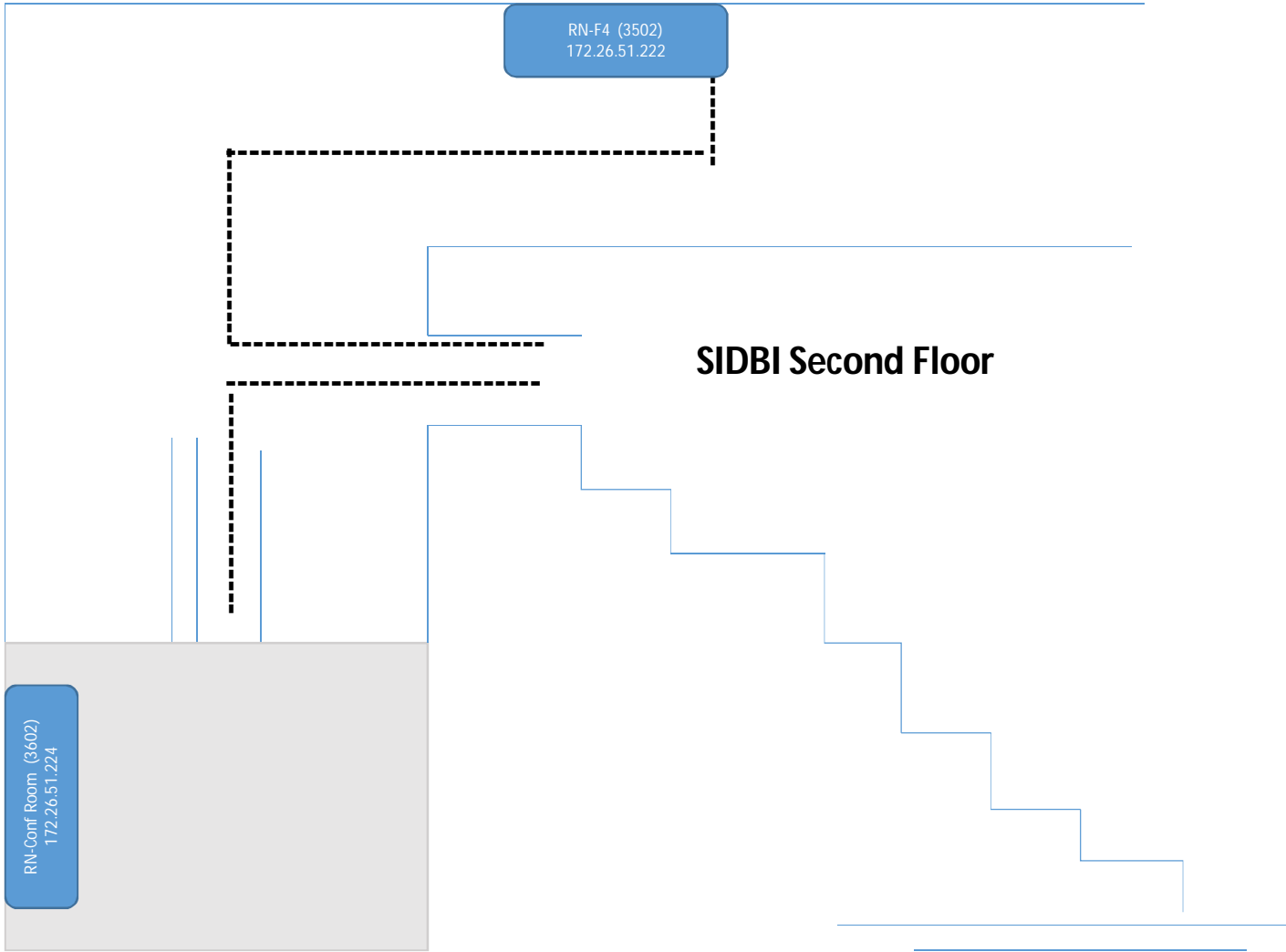

SIDBI Third Floor

RN-3rd Floor(3502)
172.26.51.225

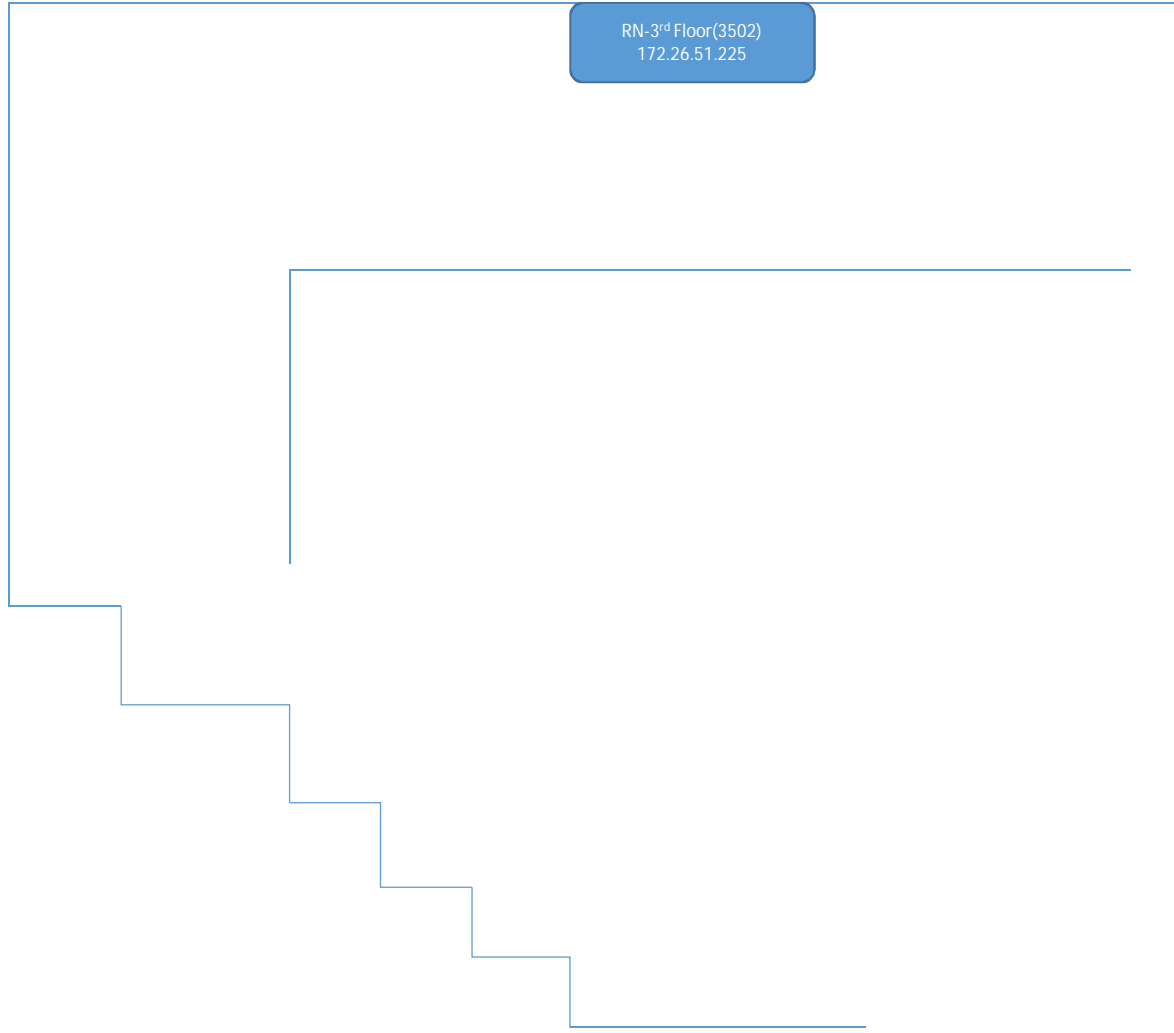

SL GF

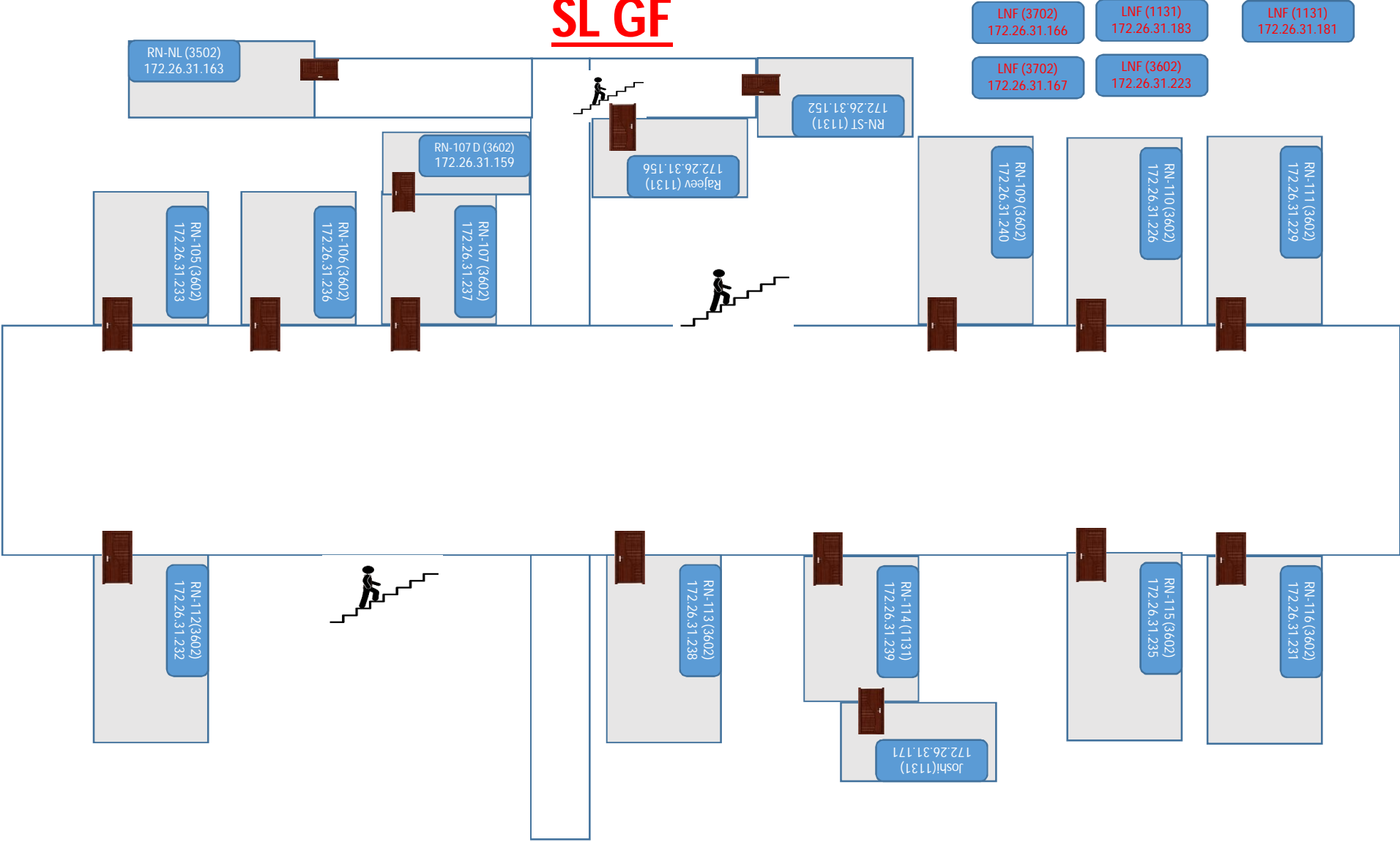

SL 1st Floor

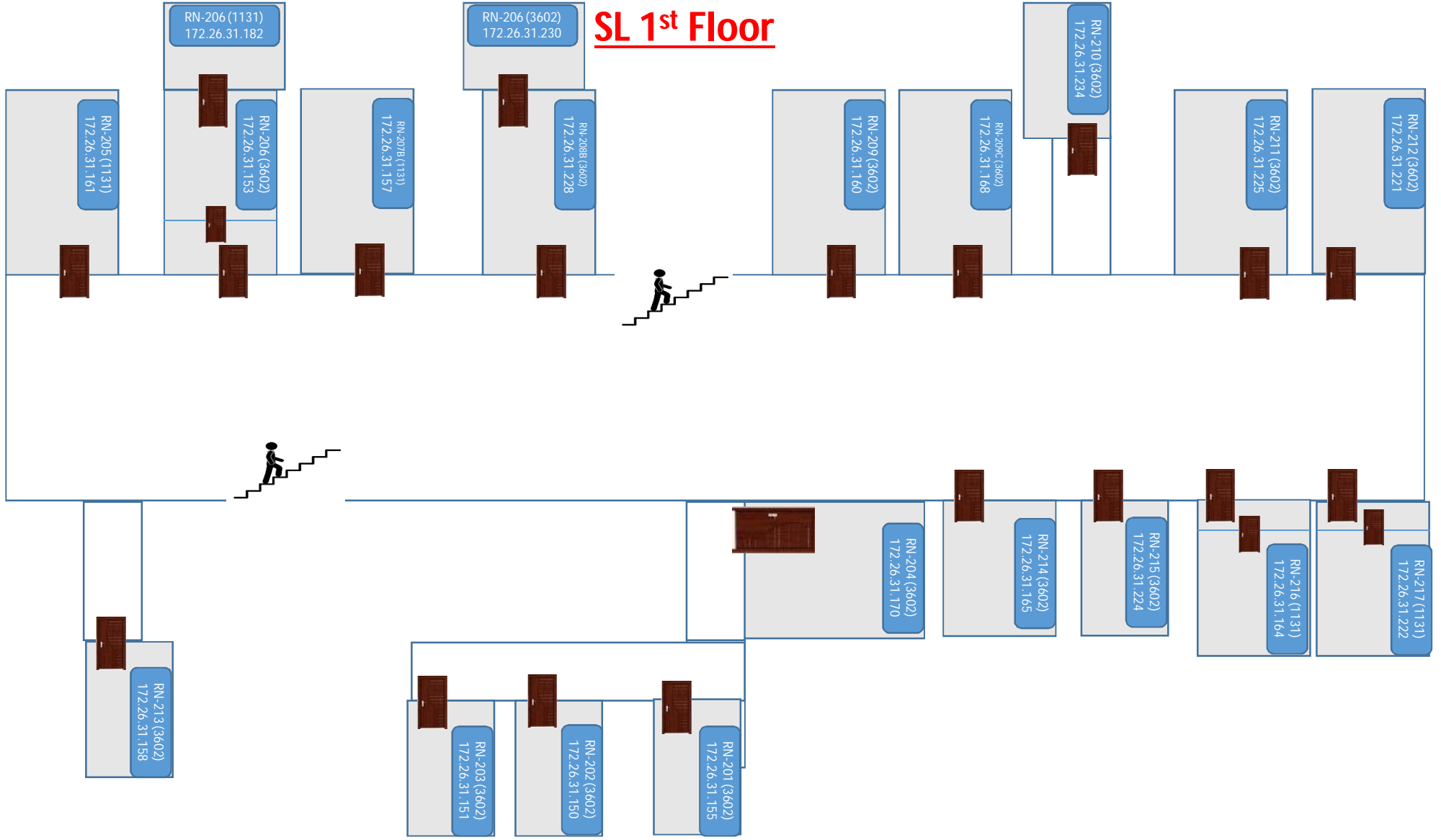

SL 2nd Floor

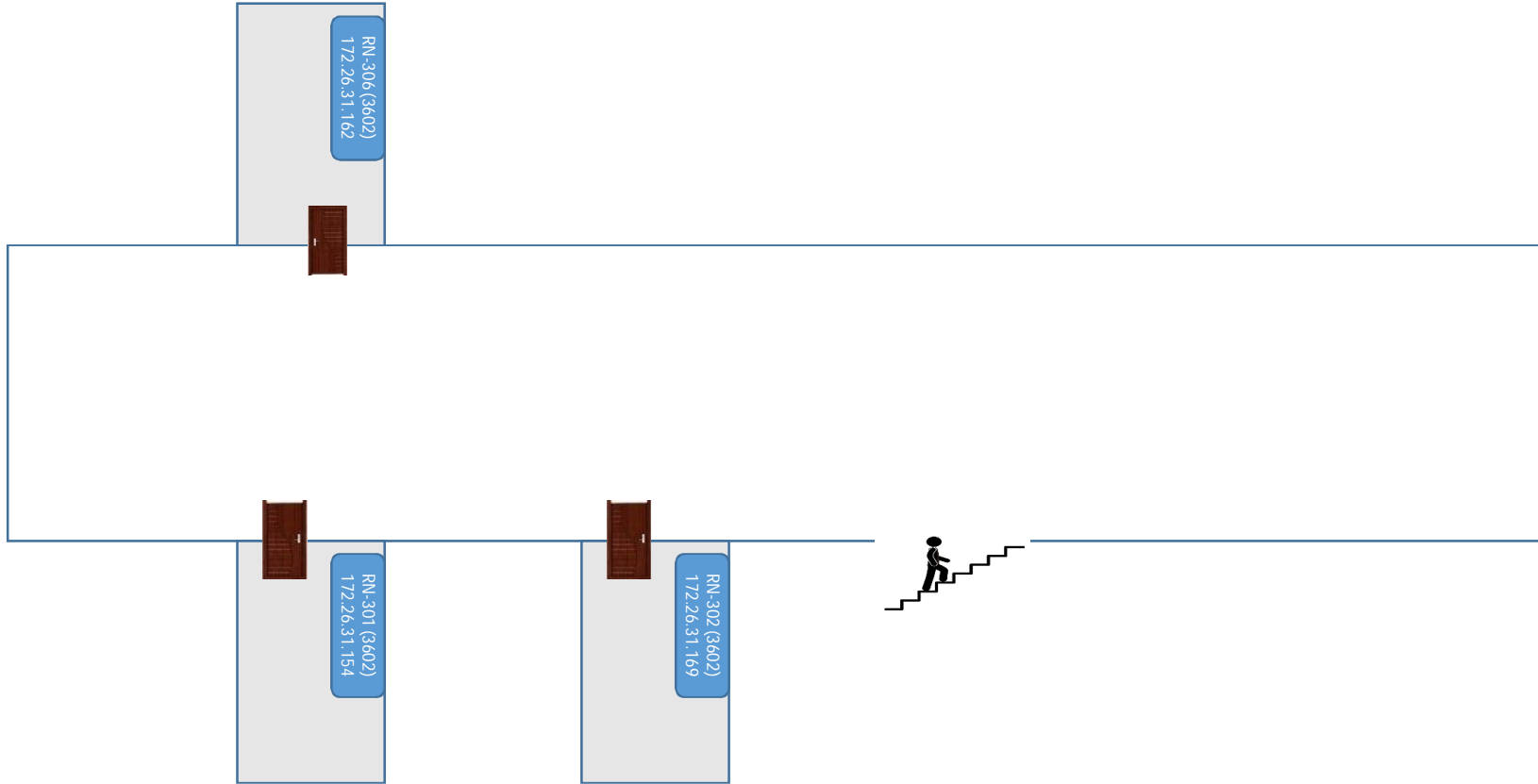

WL 1st Floor

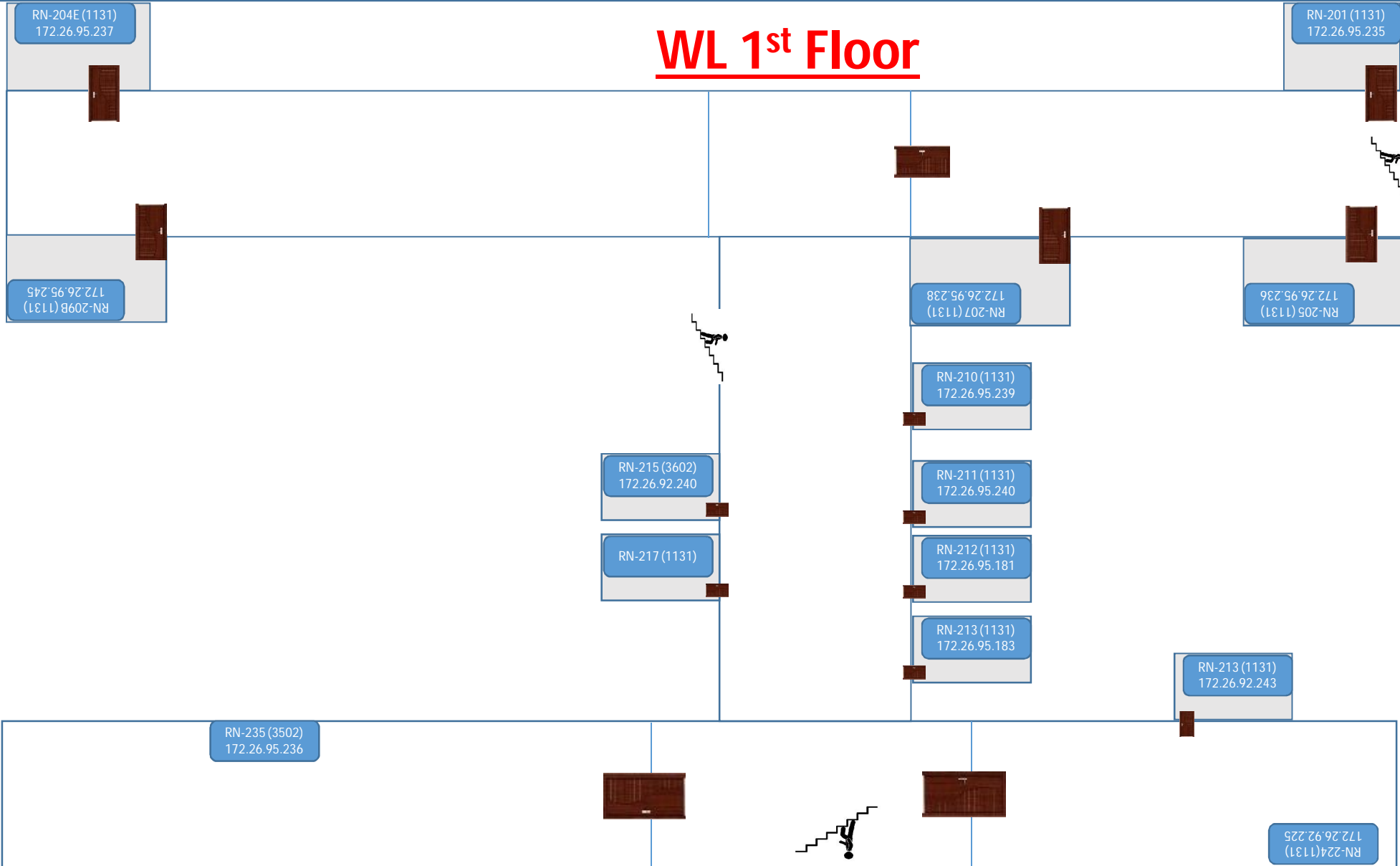

WL 2nd Floor

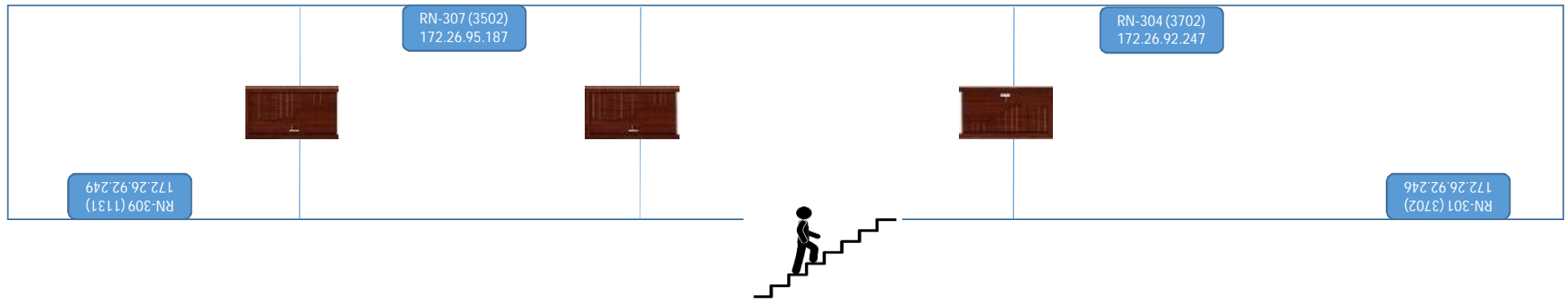

WL LNF

LNF (1131)
172.26.92.234

LNF (3502)
172.26.92.227

LNF (1832)
172.26.92.100

LNF (3602)
172.26.92.222

LNF (1131)
172.26.92.223

LNF (1131)
172.26.92.224

LNF (1131)
172.26.92.228

LNF (1832)
172.26.92.101

LNF (1131)
172.26.92.229

LNF (1131)
172.26.92.249

LNF (1131)
172.26.92.242

LNF (1131)
172.26.92.238

LNF (1131)
172.26.95.217

LNF (1131)
172.26.94.151

LNF (1131)
172.26.95.226

LNF (1131)
172.26.95.228

LNF (1131)
172.26.95.234

LNF (1131)
172.26.95.233

LNF (1131)
172.26.95.230

LNF (1131)
172.26.95.223

LNF (1131)
172.26.95.231

LNF (1131)
172.26.95.222

LNF (1131)
172.26.95.229

LNF (1131)
172.26.95.224

LNF (1131)
172.26.95.221

LNF (3502)
172.26.95.227

LNF (1131)
172.26.95.232

LNF (1131)
172.26.95.225

LNF (1131)
172.26.92.230

LNF (1131)
172.26.92.235

LNF (1131)
172.26.92.232

LNF (1131)
172.26.92.231

LNF (1131)
172.26.92.233

Western Lab Extension 1st Floor

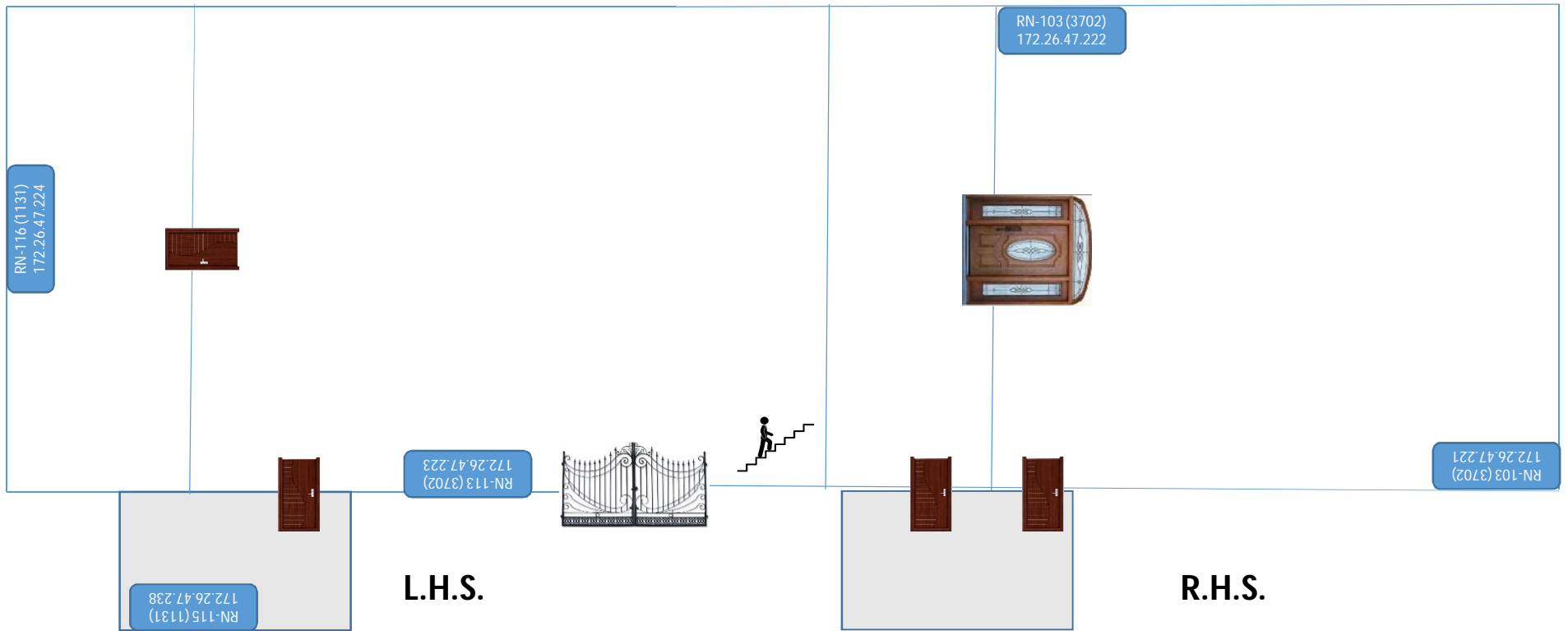

Western Lab Extension 2nd Floor

RN-217 (1131)
172.26.47.228

RN-211 (1131)
172.26.47.227

RN-201-C (1131)
172.26.47.226

RN-201-D (1131)
172.26.47.225

L.H.S.



RN-202 (1131)
172.26.47.237

A brown door icon located on the right side of the lower section.

R.H.S.

Western Lab Extension 3rd Floor

RN-314 (1131)
172.26.47.231

RN-304 (3702)
172.26.47.230

RN-301A (1131)
172.26.47.234

RN-313 (1131)
172.26.47.232



LHS

RHS

RN-303-G (3702)
172.26.47.229

